

# Controllers for Multiplexed Cabinets XM678D Rel. 5.4

## Installing and Operating Instructions

### 1 Introduction

#### 1.1. General Warnings

Please read the following safety precautions and warnings before using this manual:



##### CAUTION!

- This manual is part of the product and should be kept near the device for easy and quick reference.
- The device should not be used for purposes different from those described in this manual. It cannot be used as a safety device.
- Check the application limits before proceeding.
- Emerson reserves the right to change the composition of its products, even without notice, ensuring the same and unchanged functionality.



##### SAFETY PRECAUTIONS!

- Check that the supply voltage is correct before connecting the device.
- Do not expose to water or moisture: use the controller only within the operating limits and avoid sudden temperature changes with high atmospheric humidity to prevent condensation from forming.
- Warning: Disconnect all electrical connections before performing any kind of maintenance.
- Fit the probe where it is not accessible by the end user. The device must not be opened.
- In case of failure or faulty operation, send the device back to the distributor or to Emerson with a detailed description of the fault.
- Verify the maximum current that can be applied to each relay (see Section 20, Technical Data).
- Ensure that the wires for probes, loads, and the power supply are separated and far enough from each other without crossing or intertwining.
- In case of applications in industrial environments, the use of main filters in parallel with inductive loads could be beneficial.

### 2 Before Proceeding

#### 2.1. Software Release of XM678D

1. Look at the software release of XM678D printed on the label of the controller.

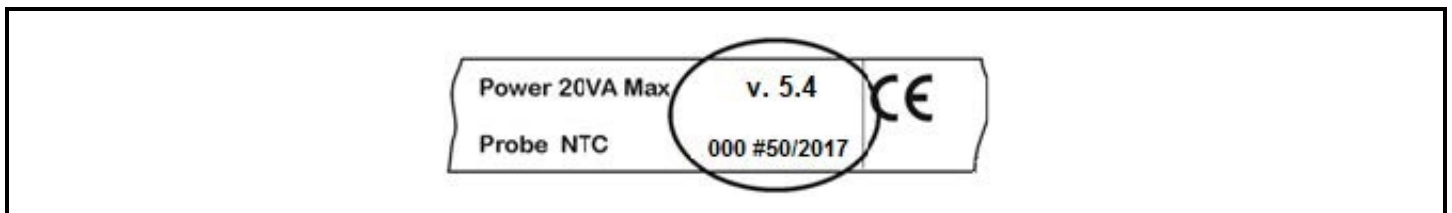

Figure 2-1 - Software Release of XM678D 5.4

2. If the software release is 5.4, proceed with this manual; otherwise contact Emerson to access the correct manual.
3. Note that RTC is not supported on devices connected to E2, E3, and Site Supervisor.

# 3 General Description

The **XM678D** is a high level microprocessor based controllers for multiplexed cabinets suitable for applications on medium or low temperature. They can be inserted in a LAN of up to eight (8) different sections that can operate, depending on the programming, as stand alone controllers or following the commands coming from the other sections. The XM678D is provided with four (4) and six (6) relay outputs respectively to control the solenoid valve, defrost that can be either electrical or hot gas, evaporator fans, the lights, an auxiliary output (XM678D) and an alarm output (XM678D) and with one output to drive **stepper electronic expansion valves**. The devices are also provided with four probe inputs, one for temperature control, one to control the defrost end temperature of the evaporator, the third for the display and the fourth can be used for application with virtual probe or for inlet/outlet air temperature measurement. In addition they are provided by other two probes that have to be used for superheat measurement and regulation. Finally, they are equipped with the three digital inputs (free contact) fully configurable by parameters.

The Hotkey connector allows simple programming of the controller. The optional direct serial output **RS485** that is **MODBUS-RTU** compatible permits simple XWEB interfacing. Depending on the model, the Hotkey connector can be used to connect the **X-REP** display.

## 3.1. Ordering Codes

Part Number	Description
318-6601	XM678D Case Controller Stepper Control, 24V, V5.4, GND, CPC+4.20, with Connectors
318-6750	Remote Display Keyboard CX660 for XMs
318-6751	Remote Display Keyboard CH660 for XMs

Table 3-1 - Product Ordering Codes

# 4 Installation and Mounting

This device can operate without any user interface, but normal application is with CX660 or CH660 keyboard (both 660 displays are supported).



This device can operate without any user interface, but normal application is with CX660 keyboard.

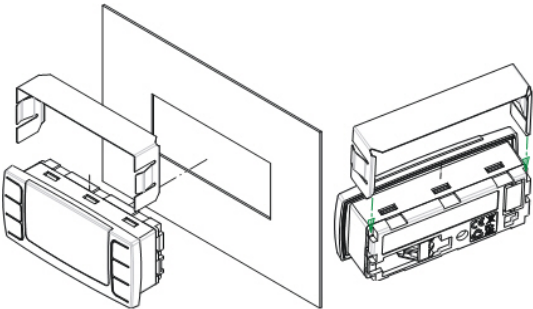

The **CX660 keyboard** should be mounted on a vertical panel, in a 29 x 71 mm hole, and secured using the special bracket supplied **Figure 4-1**

The temperature range allowed for correct operation is 32 to 140°F (0 to 60°C). Avoid places subject to strong vibrations, corrosive gases, excessive dirt or humidity. The same recommendations apply to probes. Allow air to circulate through the cooling holes.

Figure 4-1 - CX660 Keyboard Installation and Mounting

## 4.1. Dimensions

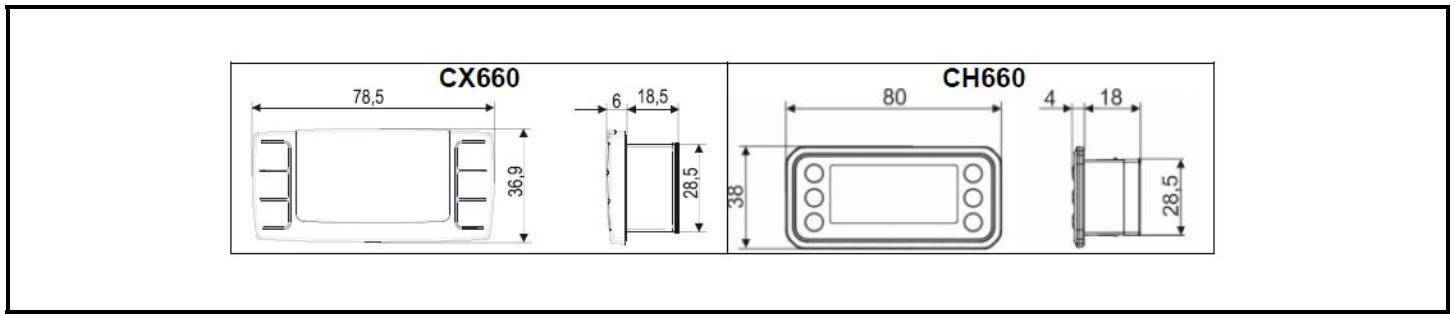

Figure 4-2 - CX660 and CH660 Dimensions

# 5 Wiring Diagram and Connections

## 5.1. Important Note

The **XM** device is provided with a disconnectable terminal block to connect cables with a cross-section of up to 1.6 mm<sup>2</sup> for all low voltage connections: RS485, LAN, probes, digital inputs, and keyboard. Other inputs, power supply and relay connections are provided with a screw terminal block or Faston connection (5.0 mm). Heat-resistant cables have to be used. Before connecting the cables, verify that the power supply complies with the controller's requirements. Separate the probe cables from the power supply cables, outputs and power connections. Do not exceed the maximum current allowed on each relay. In case of heavier loads, use a suitable external relay. *N.B Maximum current allowed for all loads is 16A.*

The probes should be mounted with the bulb upwards to prevent damages due to casual liquid infiltration. It is recommended to place the thermostat probe away from air streams to measure the average room temperature correctly. Place the defrost termination probe among the evaporator fans in the coldest place (where most ice is formed) and far from heaters or from the warmest place during defrost to prevent premature defrost termination.

## 5.2. XM678D

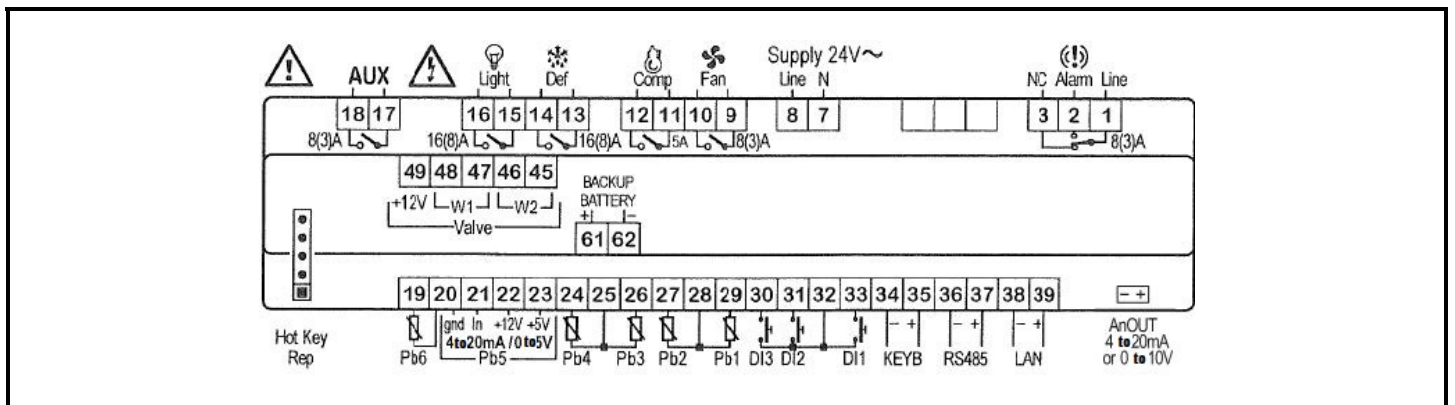

Figure 5-1 - Wiring and Connections

## 5.3. Valves Connections and Configuration

### 5.3.1. Valve Connections

All connections between XM678D and valve must be done with the controller NOT supplied.

### 5.3.2. Type of Cables and Max Length

To connect the valve to the controller, use only shielded cables with section greater than or equal to 0.823 mm<sup>2</sup> (AWG18). A twisted shielded cable with the above specification is suggested. Do not connect the shield to any ground, leave it floating. The max distance between an XM controller and a valve **must not exceed 10 meters**.

### 5.3.3. Valve Selection

To avoid possible problems, before connecting the valve, configure the driver by making the correct changes on the parameters.

- a. Select the kind of motor (**tEU parameter**).
- b. Check if the valve is present in **tEP parameter table** reported here below.

Check the following table for a right setting.

In any case, the unique and valid reference has to be considered the data sheet made by valve manufacturer. Emerson cannot be considered responsible in case of valve damaging due to wrong settings.

tEP	Model	LSt (steps*10)	uST (steps*10)	CPP (mA*10)	CHd (mA*10)	Sr (step/s)	tEu (bip/ unip)	HSF (Half/ Full)
0	Manual settings	Par	Par	Par	Par	Par	Par	Par
1	Danfoss EST-25/50	7	262	10	10	300	bP	FUL
2	Danfoss EST-100	10	353	10	10	300	bP	FUL
3	Danfoss EST-250/400	11	381	10	10	300	bP	FUL
11	Emerson EX4/EX5/EX6	5	75	50	10	300	bP	FUL

Table 5-1 - tEP Parameter Setting

If you can look up your valve in the table, please select the valve through **tEP parameter** to verify correct configuration. Use the following table for quick reference on the connection mode for valves of different manufacturers.

#### 4 Wires Valves (Bipolar)

Connection Numbering	ALCO EX4/5/6/7/8	DANFOSS ETS
45	BLUE	BLACK
46	BROWN	WHITE
47	BLACK	RED
48	WHITE	GREEN

Table 5-2 - Bipolar Valves

#### 5-6 Wires Valves (Unipolar)

Connection Numbering	SPORLAN	SAGINOMIYA
45	ORANGE	ORANGE
46	RED	RED
47	YELLOW	YELLOW
48	BLACK	BLACK
49- Common	GRAY	GRAY

Table 5-3 - Unipolar Valves

1. After selecting the valve, switch the controller OFF and ON to load the new settings.
2. Switch OFF the controller before connecting the valve. Make the connection with controller OFF.
3. Switch the controller ON.

## 5.4. Absolute Maximum Power

**XM678D** is able to drive a wide range of stepper valves, indicated in the following table are the maximum values of current that the actuator can supply to the stepper wiring. The **TF20D** Dixell transformer has to be used.

**NOTE:** The electrical power absorption of the valve can be unrelated to refrigeration power of the valve. Before using the actuator, read the valve manufacturer's technical manual and check the maximum current used to drive the valve to verify that they are lower than those indicated below.

VALVE TYPE	BIPOLAR VALVES (4 wires)	Maximum Current 0.5A
	UNIPOLAR VALVES (5-6 wires)	Maximum Current 0.33A

Table 5-4 - Valve Type

## 5.5. Keyboard Display CX660

The XM678D board can operate also without keyboard.

**Polarity:**  
Terminal [34] [-]  
Terminal [35] [+]

Use twister shielded cable AWG 18 or less in case of long distance.

**Max distance:** 30 meters

Figure 5-2 - Keyboard Display

## 5.6. LAN Connection

To create a LAN connection and to perform synchronized defrost (also called master-slave functioning):

1. Connect a shielded cable between terminals 38 [-] and 39 [+] for a **maximum of eight (8) sections**.
2. The **Adr** parameter is the number that identifies each electronic board. *Address duplication is not permitted*; in this case, synchronized defrost and the communication with the monitoring system are not guaranteed (the **Adr** is also the MODBUS address). See **Figure 5-3** for an example of a properly configured LAN connection:

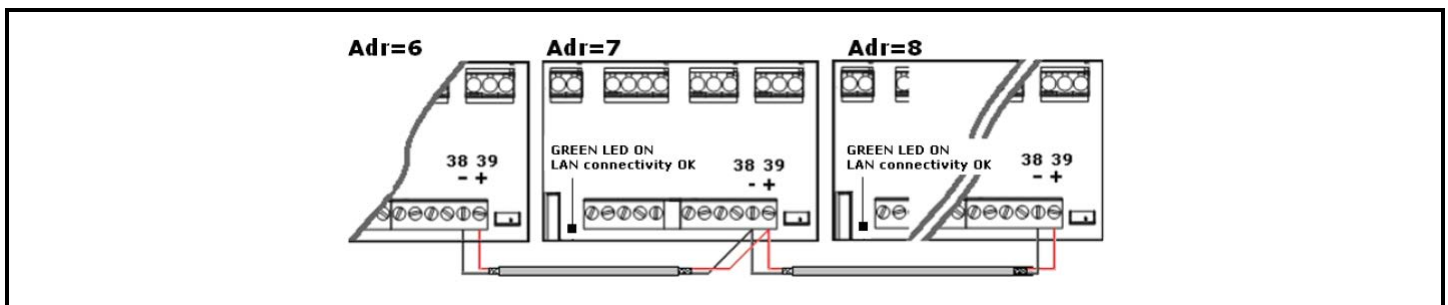
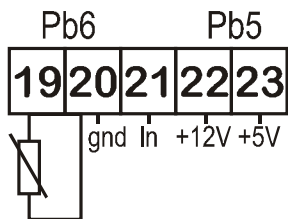

Figure 5-3 - LAN Connection



**NOTE:** If the LAN is connected properly, the green LED will be ON. If the LAN is not connected properly, a blinking LED will display. The maximum allowed distance is 30 meters.

## 5.7. Sensors for Superheat Control .



**Temperature probe: Pb6** Terminals 19-20 without any polarity.

Select the sensor type with the **P6C** parameter.

**Pressure transducer: Pb5** Terminals

[21] = signal input

[22] = power supply for 4 to 20mA transducer

[20] = GND

[23] = +5VDC power supply for ratio-metric pressure transducer

Select the transducer configuration with the **P5C** parameter.

Figure 5-4 - Sensors for Superheat Control

## 5.8. How to Use a Single Pressure Transducer on Multiplexed Applications

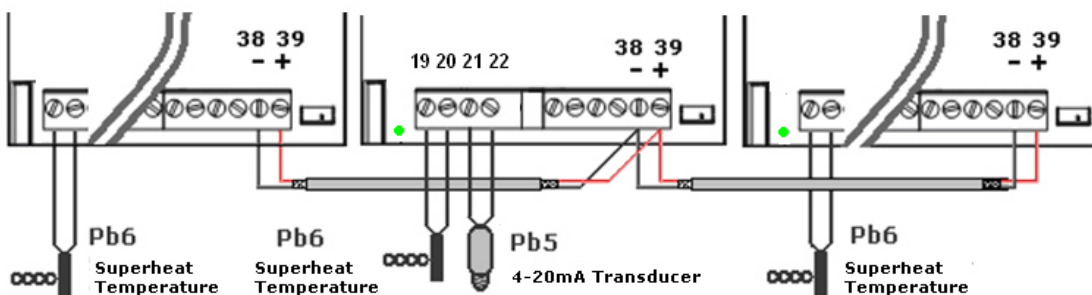

Figure 5-5 - Pressure Transducer on Multiplexed Applications

A working LAN connection is required (green LED illuminated on all XM670- XM678D boards of the same LAN). Connect and configure the pressure transducer only on **one** XM670- XM678D of the network. Afterwards, the pressure value read by that single transducer will be used by each device connected to the same LAN.

To read the pressure value, press the **up arrow** button to access the fast selection menu and read the value of the following parameters:

- **dPP** - Measured pressure (only on the master device)
- **dP5** - Temperature value obtained from the pressure value (temperature conversion)
- **rPP** - Pressure value read from remote location (only for slave devices)

Examples of error messages:

- **dPP = Err** - The local transducer read an incorrect value; the pressure value is out of range of the pressure transducer or the **P5C** parameter is incorrect. Check if any of the above causes the error, otherwise replace the transducer.
- **rPF** - There is an error in the remote pressure transducer. Check the status of the board (GREEN LED); if the LED is OFF, the LAN is not functioning; otherwise, check the remote pressure transducer.

### Last Checks about the Superheat:

On the fast access menu:

- **dPP** - The value read by the gauge.
- **dP6** - The value read by the temperature probe, the temperature of the gas on the evaporator outlet.
- **SH** - The value of the superheat. The **nA** or **Err** message means that the superheat cannot be read at the moment and the value is not available.

## 5.9. How to Connect the Monitoring System

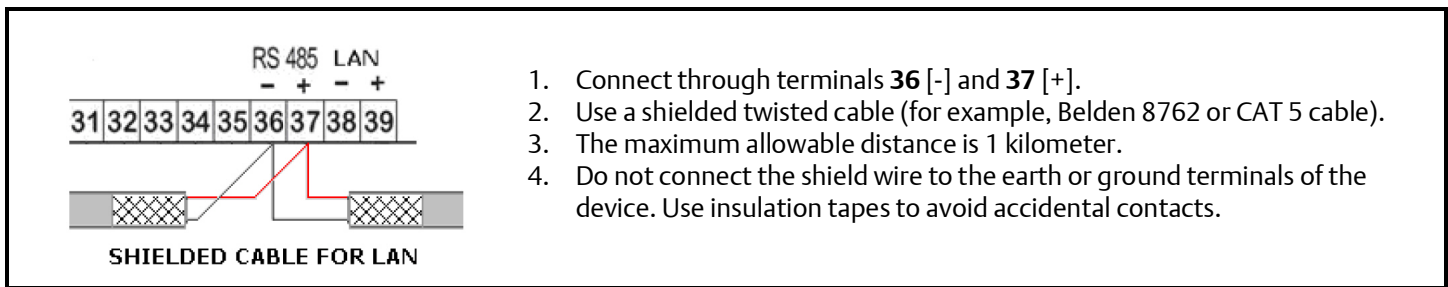

Figure 5-6 - Connecting the Monitoring System

Only one controller for each LAN should be connected to the RS485 connection.

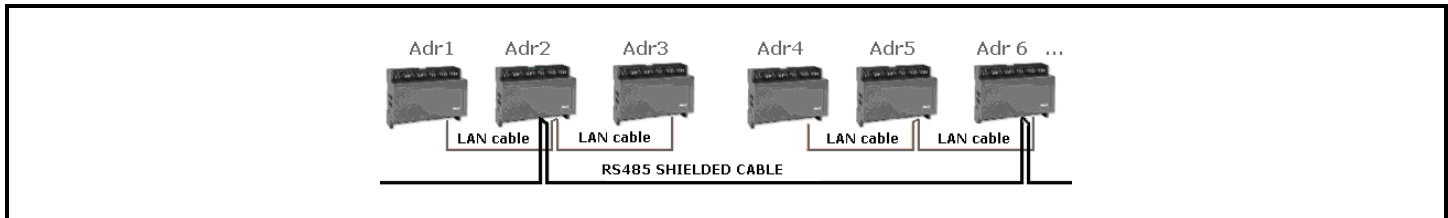

Figure 5-7 - Connecting Monitoring Systems

The **Adr** parameter is the number that identifies each electronic board. **Address duplication is not permitted**; in this case, synchronized defrost and the communication with the monitoring system are not guaranteed (the **Adr** is also the MODBUS address).

## 5.10. Digital Inputs

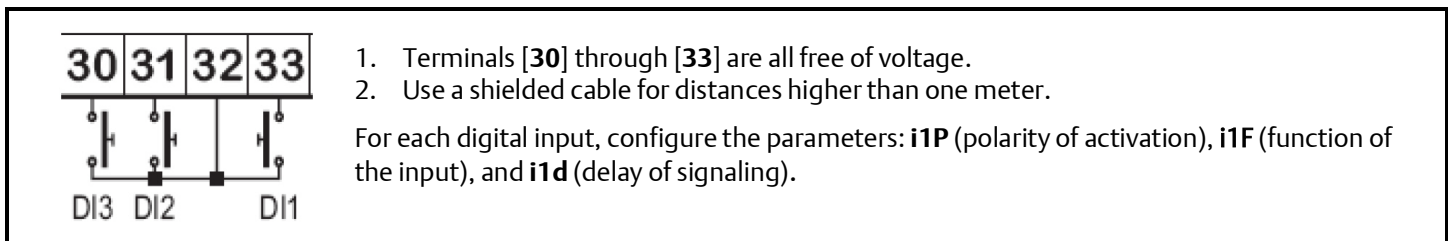

Figure 5-8 - Digital Inputs

The **i1P** can be set to: **cL** = active when closed; or **oP** = active when opened.

The **i1F** parameter can be set to: **EAL** = external alarm, **Bal** = serious lock alarm, **PAL** = pressure switch alarm, **dor** = door switch, **dEF** = external defrost, **AUS** = auxiliary activation command, **LiG** = light activation, **OnF** = board On/OFF, **FHU** = do not use this configuration, **ES** = day/night, or **HdY** = do not use this configuration.

The **i1d** parameter is for the delay of activation.

For the other digital inputs, same set of parameters is present: **i2P**, **i2F**, **i2d**, **i3P**, **i3F**, **i3d**.

## 5.11. Analog Output

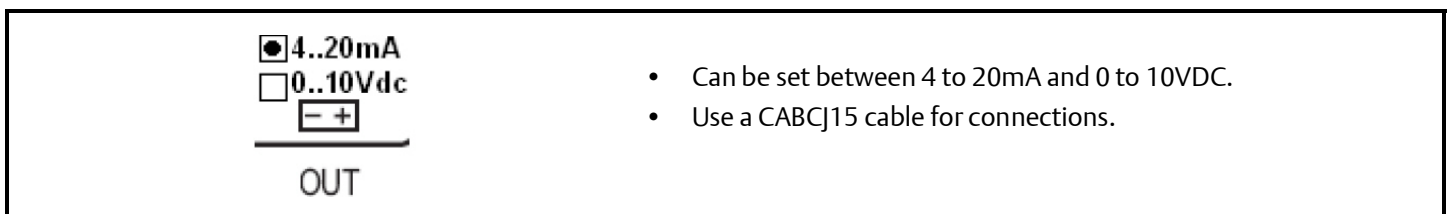

Figure 5-9 - Analog Output

The analog output is located near the terminal [39] on a two-pin connector. The analog output can be used to control anti-sweat heaters using a chopped phased controller, XRPW500 (500 watt) or family, XV...D or XV...K.



# 6 Quick Reference Guide in Running the Self Adaptive Regulation

1. After wiring the XM678D; **set the proper gas** using the **Fty** parameter.
2. **Set the proper gas via Fty** parameter. Preset gas is **R404A**.

LABEL	REFRIGERANT	OPERATING RANGE
R22	r22	-58 to 120°F / -50 to 60°C
134	r134A	-58 to 120°F / -50 to 60°C
290	r290 – Propane	-58 to 120°F / -50 to 60°C
404	r404A	-94 to 120°F / -70 to 60°C
47A	r407A	-58 to 120°F / -50 to 60°C
47C	r407C	-58 to 120°F / -50 to 60°C
47F	r407F	-58 to 120°F / -50 to 60°C
410	r410A	-58 to 120°F / -50 to 60°C
448	r448A	-49 to 120°F / -45 to 60°C
449	r449A	-49 to 120°F / -45 to 60°C
450	r450A	-49 to 120°F / -45 to 60°C
452	r452A	-94 to 120°F / -70 to 60°C
507	r507	-94 to 120°F / -70 to 60°C
513	r513A	-49 to 120°F / -45 to 60°C
CO2	r744 - Co2	-58 to 77°F / -50 to 25°C
15b	r515b	-22 to 120°F / -30 to 60°C
54A	r454A	-58 to 120°F / -50 to 60°C
54b	r454B	-58 to 120°F / -50 to 60°C
54C	r454C	-58 to 120°F / -50 to 60°C
55A	r455A	-40 to 120°F / -40 to 60°C
4yF	r1234yf	-58 to 120°F / -50 to 60°C
4EE	r1234ze	-58 to 120°F / -50 to 60°C

3. Configure the probes:

- **Regulation and evaporator probes** are preset as NTC. If another kind of sensors is used, it can be set to P1c and P2c parameters.
- **Superheat evaporator outlet probe** is preset as Pt1000, if another kind of sensor is used, it can be set to P6c parameter.
- The **PP11** (-0.5 to 11 bar) is preset as **pressure probe**. It operates at relative pressure (Pru = rE). If you are using a ratiometric transducer, set **P5c = 0-5**. Use parameters **PA4** and **P20** to set the range.



**NOTE:** Check the pressure gauge reading with the value of dPP. Press the up arrow once to enter the Fast Access Menu. If OK, proceed; otherwise, resolve the situation before acting on the parameter.

4. Set the parameters for self adaptive regulation of superheat.



**NOTE:** The parameters Pb (regulation band) and Int (integral time) are automatically calculated by the controller.

- Set **CrE = no**, this disables the continuous regulation of the temperature. Default is CrE = no.
- Set **SSH, superheating setpoint**. A value between 4 and 8 is acceptable. Default is SSH=6.
- Set **ATU = y**, this starts the **self adaptive regulation**. Default is ATU = y.
- Set **AMS = y**, this starts the search of the **lowest stable superheat**. Default is AMS = n. This function reduces the setpoint automatically in order to optimize the use of the evaporator, and keeping the superheating regulation stable at the same time. The minimum allowed SH setpoint is LSH+2 LSH+2°C.
- Set **LSH, low superheating limit**. A value between 2 to 4 is acceptable. Default is LSH = 2.
- Set **AnP, pressure filter**. Default is AnP =3. The value can increase up to 10 if the pressure variation responds too fast.

5. Set the parameters for the temperature regulation.

- Set the temperature **setpoint**. Default is 2°C.
- Set the **differential HY** Default is 2°C.
- If the **capacity of the valve** is higher than requested, it can be reduced by the parameter. **MnF** (default is 100). A proper setting of **MnF** will reduce the time that the algorithm takes to reach the stability. MnF value does not affect the bandwidth.



# 7 Battery Back Up Connection

## 7.1. Connection of XEC Supercap

XEC Supercap is designed to be used with Emerson products (XM678D, XEV, IEV, and others); compatibility with Emerson devices has to be verified in the user manual/technical sheet of the device.

For more information, please contact Emerson Technical Support at 833-409-7505 or email [ColdChain.TechnicalServices@Emerson.com](mailto:ColdChain.TechnicalServices@Emerson.com).

**NOTE:** XEC Supercap and XM678D must be powered by two different transformers; the failure of the observance of this rule may result in damage to the XEC Supercap and / or the connected XM678D.

### Wiring Connection

XM678D	XEC
Terminal 61 (+)	Terminal 4 (12Vdc)
Terminal 62 (-)	Terminal 3 (gnd)

Table 7-1 - XM678D and XEC Wiring Connection

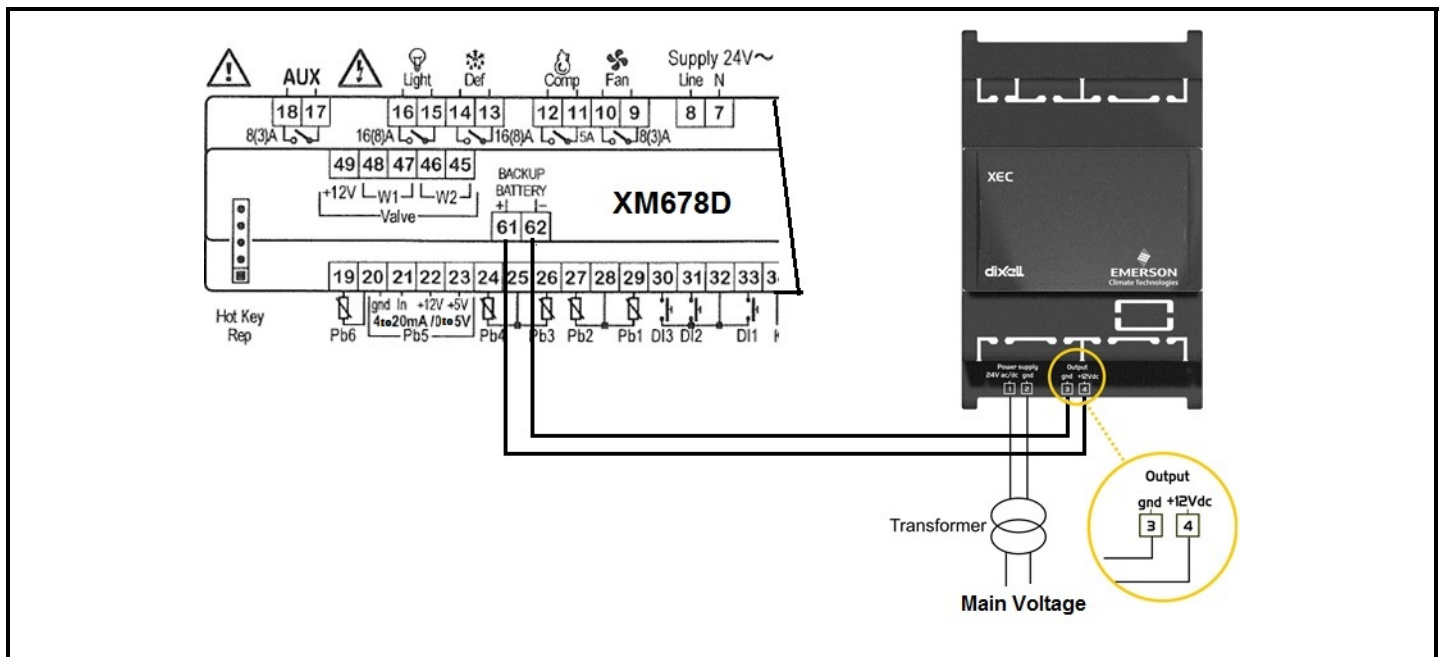

Figure 7-1 - XEC Supercap Connection

## 7.2. Emerson ECP-024 Connection

The ECP-024 rechargeable accumulator can be connected to the XM678D to close the stepper valve in case of power interruption.

### Wiring Connection

XM678D	ECP-024
Terminal 61 (+)	Terminal +
Terminal 62 (-)	Terminal -

Table 7-2 - XM678D and ECP-024 Wiring Connection

About conditions of use and limitation please refer to the ECP-024 manuals.

Document Part # 026-4278 Rev 2

©2022 Emerson Digital Cold Chain, Inc. This document may be photocopied for personal use. Visit our website at [www.climate.emerson.com](http://www.climate.emerson.com) for the latest technical documentation and updates.

# 8 User Interface

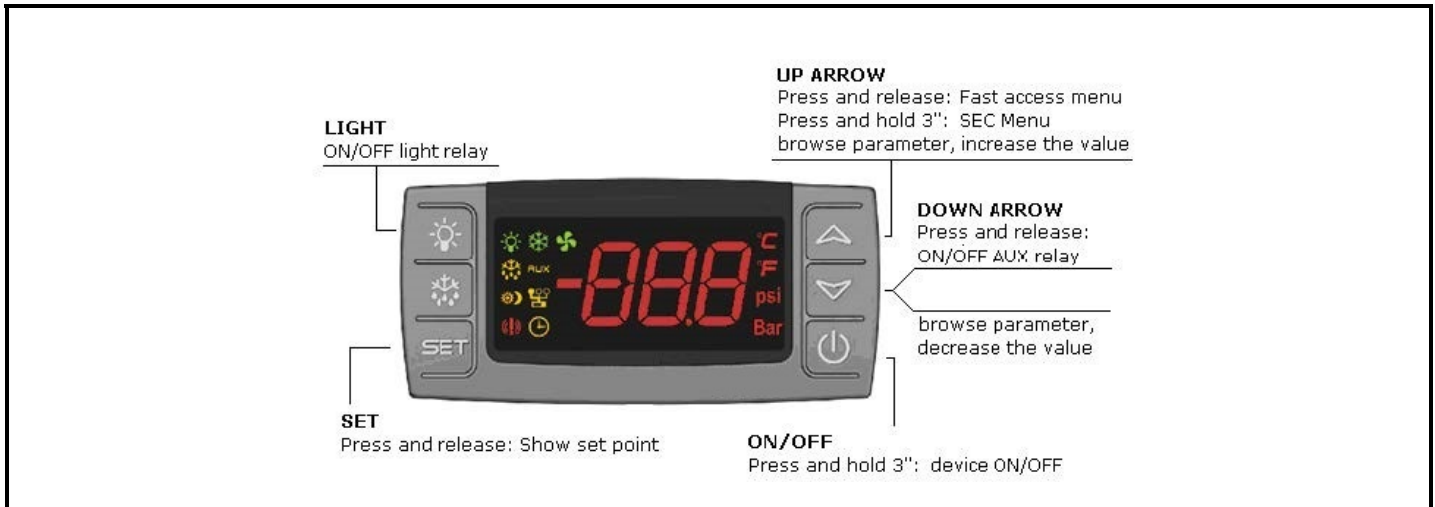

Figure 8-1 - XM678D Display

## 8.1. Icons

Cooling Output					
Light				Fan	The output is activated when the icon is ON. A delay is present when the icon is blinking.
Defrost		AUX	Auxiliary relay		
Energy Saving			Multimaster enabled		MEASUREMENT UNIT °C, Bar, and ⌚ (time) are ON depending on the selection.
Generic alarm			Clock/time		
<b>DURING PROGRAMMING:</b> The measurement units of temperature and pressure will blink.					

Table 8-1- XM678D Display Icons

## 8.2. Keyboard Commands

Single commands:

- LIGHT relay: Press the light button
- AUX relay: Press the down arrow button
- Manual defrost: Press the defrost button for three (3) seconds
- ON/OFF: Press the **ON/OFF** button for three (3) seconds (if the function is enabled)
- ES: Press the **ON/OFF** button for three (3) seconds (if the function is enabled)

## 8.2.1. Double Commands



	Press for three (3) seconds to lock (Pon) or unlock (PoF) the keyboard.
<b>SET</b> + 	Press both keys to exit the programming mode or from a menu; when on submenus <b>EEV</b> , pressing these keys return you to the previous level.
<b>SET</b> + 	Press both keys for three (3) seconds to enter the first level of the programming mode.

Table 8-2 - Keyboard Double Commands

## 8.3. How to Modify the Air Temperature Regulation Setpoint

The thermostat setpoint is the value used to regulate the air temperature. The regulation output is controlled by the electronic valve or the relay.

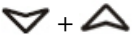

BEGIN	<b>SET</b>	Press the <b>SET</b> key for three (3) seconds (the measurement units will blink).
Value modification	 or 	Use the up arrow and down arrow keys to change the LS and US parameters value.
EXIT	<b>SET</b>	Press the <b>SET</b> key to save the value (the value will blink for two (2) seconds).

Table 8-3 - Modifying the Air Temperature Regulation Setpoint

In any case, it is possible to wait for about 10 seconds to exit. In order to show the air temperature set is sufficient to press and release the SET button, the value is displayed for about 60 seconds for a **KEY COMBINATIONS**.

# 9 How to Program the Parameters (Pr1 and Pr2)

The device has two programming levels: **Pr1** (direct access) and **Pr2** (password-protected, access for higher level users).







ACCESS to Pr1	<b>SET</b> + 	Press for three (3) seconds to enter the first programming level (Pr1).
Select item	 or 	Press the up arrow or down arrow key to select the parameter or submenu.
Show value	<b>SET</b>	Press the <b>SET</b> button.
Modify	 or 	Press the up arrow or down arrow key to change the value.
Confirm and store	<b>SET</b>	Press <b>SET</b> (the value will blink for three (3) seconds and then display the next parameter).
EXIT	<b>SET</b> + 	Press to exit the programming mode, or wait for 10 seconds to exit.

Table 9-1 - Programming the Parameters (Pr1 and Pr2)

## 9.1. How to Enter Pr2

To enter **Pr2** programming menu:

1. Press **SET+ down arrow** keys for three (3) seconds to enter **Pr1** menu (the first label will display).
2. Press **down arrow** until the **Pr2** label displays and then press **SET**.
3. A blinking “PAS” label displays. Wait for a few seconds.
4. When a blinking “0 - -” displays, enter the password [**321**] by pressing the up arrow and down arrow keys. Press **SET** to save.

**GENERAL STRUCTURE:** The first two items, rtC and EEV, are related to the submenus of the other parameters.

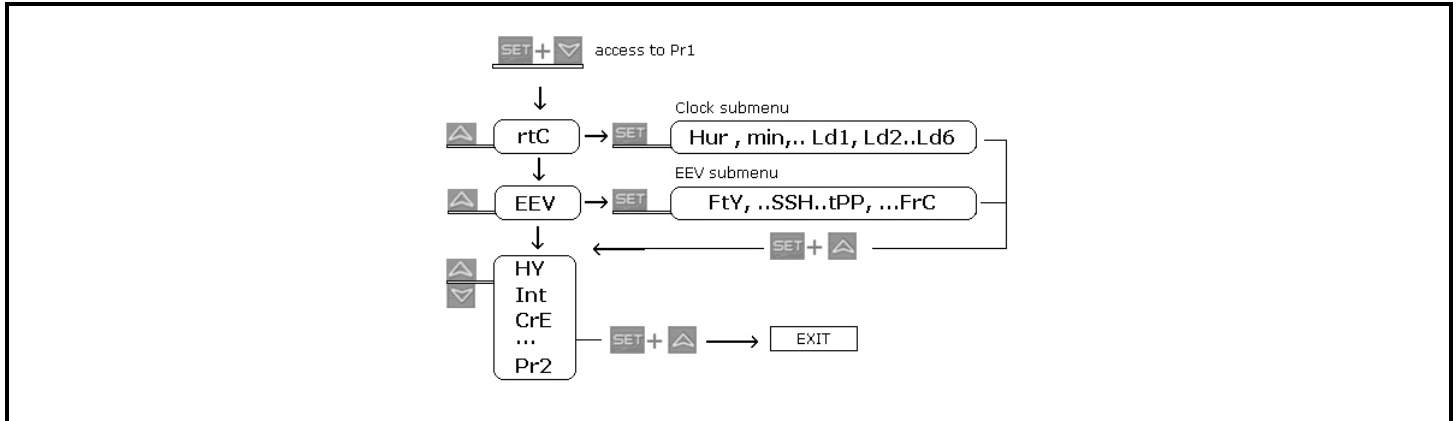

Figure 9-1 - General Structure

- Pressing the **SET + up arrow** keys on the rtC or EEV submenu returns you to the parameter list.
- Pressing the **SET + up arrow** keys on the parameter list exits the screen.

## 9.2. How to Move a Parameter From Pr1 to Pr2 Level and Vice Versa

Enter the Pr2 level and select the desired parameter then press the **SET+ down arrow** keys. If the LED on the left-hand side of the screen is ON, it means that the parameter is present in Pr1 level; if the LED is OFF, it means that the parameter is not present in Pr1 (Only Pr2).

# 10 Fast Access Menu

The Fast Access menu contains the list of probes and values that are automatically emptied by the board such as the superheat and percentage of valve opening. The values: **nP** or **noP** stands for probe not present or value not emptied, and **Err** means the value is out of range, or the probe is damaged, not connected or configured incorrectly.

ENTERING THE FAST ACCESS MENU	▲	Press and release the <b>up arrow</b> key. The duration of the menu in case of inactivity is about 3 minutes. Depending on the configuration of the board, the values display.
<p>To select an entry, press the ▲ or ▼, then press <b>SET</b> to view the value or to move to the next value.</p>	<p><b>MAP</b> Current map (0 to 3): it shows which map is used  <b>HM</b> Access to clock menu or reset the RTC alarm  <b>An</b> Value of analog output  <b>SH</b> Value of superheat. nA= not Available  <b>oPP</b> Percentage of valve opening  <b>dp1</b> (Pb1) Value read by probe 1  <b>dp2</b> (Pb2) Value read by probe 2  <b>dp3</b> (Pb3) Value read by probe 3  <b>dp4</b> (Pb4) Value read by probe 4  <b>dp5</b> (Pb5) Temperature read by probe 5 or value obtained from pressure transducer  <b>dp6</b> (Pb6) Value read by probe 6  <b>dPP</b> Pressure value read by (Pb5) transducer  <b>rPP</b> Virtual pressure probe, only on slave  <b>rPP</b> Virtual pressure probe, only on slave.  <b>rCP</b> Value of P4 remote probe for heaters. It is displayed only with P4C = LAn. If the value is not available “noP” label is displayed.  <b>dPr</b> Virtual probe for room temperature regulation [<b>rPA</b> and <b>rPb</b>]  <b>rSE</b> Real thermoregulation setpoint: the value includes the sum of SET, HES and/or the dynamic setpoint if the functions are enabled.  <b>L°t</b> Minimum room temperature;  <b>H°t</b> Maximum room temperature;  <b>tMd</b> Time to next defrost (minutes)  <b>LSn</b> Number of devices in the LAN  <b>LAn</b> Address list of devices in the LAN  <b>GAL</b> To see all the active alarms in each device connected to the LAN</p>	
EXIT	SET + ▲	Press together or wait the time out for 60 seconds.

Table 10-1 - Fast Access Menu

# 11 Multi-master Function Menu (SEC)

The function “section” SEC is enabled when the  icon is illuminated. It allows entering in the remote programming mode from a keyboard not physically connected to the board through the LAN functionality.

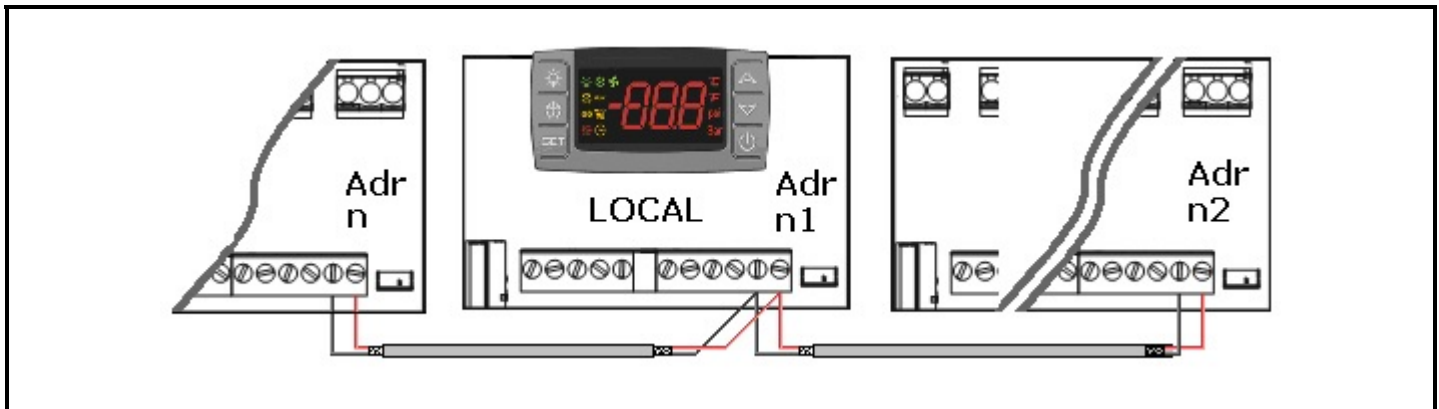

Figure 11-1 - LAN Connection





Action	Button or display	Notes
Enter menu		Press the up arrow key for about three (3) seconds, the  icon will be ON.
Waiting for action	SEC	The menu to change the section will be entered. <b>SEC</b> label will be displayed.
Enter section list	<b>SET</b>	Press <b>SET</b> to confirm. The following list will be available to select the proper network function.
Select proper function	 or  LOC GLb	To gain access only to the local device. To share global command to all the devices connected to the LAN.
Confirm	<b>SET</b>	Select and confirm an entry by pressing <b>SET</b> button.
Exit menu	<b>SET</b> + 	Press <b>SET</b> and up arrow together or wait about 10 seconds.

Table 11-1 - Multi-master Function Menu Action Buttons

(\*) The devices on the LAN are indexed by using the Adr parameter (in ascending order).

EXAMPLES:

- To send a command to in all the devices connected to the LAN: enter multi-master menu. Select and confirm **GLb**. Exit from multi-master menu. Enter the programming menu and set the parameter of global commands (from LMD to ACE). The new setting will be shared among the controllers connected to the LAN.



**CAUTION!** At the end of programming, select the LOC section to switch OFF the  icon.

## 11.1. Synchronized Defrost

The synchronized defrost allows multiple defrosts to be managed from different boards connected through the LAN connection. In this way, the boards can perform simultaneous defrosts with the possibility to end them in a synchronized manner.



**CAUTION!** In this case, the *Adr* parameter cannot be duplicated because defrost cannot be managed correctly.

BEGIN	SET +	Press for three (3) seconds, the <b>rtC</b> or other will be showed. The measurement unit blinks.
Find <i>Adr</i>		Press the down arrow key several times to find the <b>Adr</b> parameter, then press <b>SET</b> .
Modify <i>Adr</i>	 or 	Set the value of <b>Adr</b> parameter, then press <b>SET</b> to confirm the parameter.
EXIT	SET +	Press both keys to exit from menu or wait for about 10 seconds.

Table 11-2 - Synchronized Defrost Keys

The **LSn** and **LAN** parameter are used only to show the actual settings (read only). See Figure 11-2 for an example of configuration:

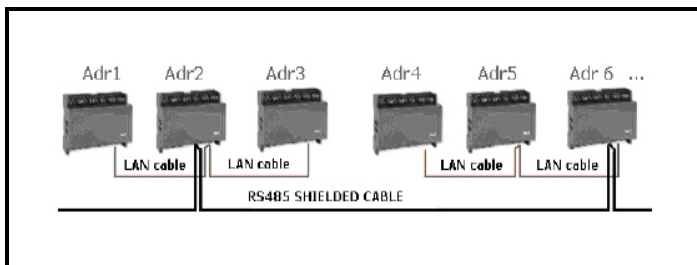

Figure 11-2 - Configuration Example

### 11.1.1. Daily Defrost From RTC: [EdF = rtC]

- **IdF Parameter:** For safety reasons, force the value of **Idf** at +1 with respect to the interval between the two **Ld** parameters. The **IdF** timer is restarted after defrost and at every power ON.
- **DEFROST START:** At the time selected by the parameters **Ld1** to **Ld6** or **Sd1** to **Sd6**.
- **DEFROST END:** If the probes reach the **dtE** temperature or for maximum **MdF** time.
- **SAFETY and RtC or RtF ALARM:** With clock alarm, the device will use the parameters **IdF**, **dtE** and **MdF**.



**CAUTION!** Do not set [EdF = rtC] and [CPb = n].

- **MULTIMASTER DEFROST:** All the probes with clock

Par	Unit A (RTC)	Unit B (RTC)	Unit C (RTC)
<b>Adr</b>	n	N + 1	N + 2
<b>IdF</b>	9 hours safety	9 hours safety	9 hours safety
<b>MdF</b>	45 minutes safety	45 minutes safety	45 minutes safety
<b>dtE</b>	12°C safety	12°C safety	12°C safety
<b>Ld1</b>	06:00 1°	06:00 1°	06:00 1°
<b>Ld2</b>	14:00 2°	14:00 2°	14:00 2°
<b>Ld3</b>	22:00 3°	22:00 3°	22:00 3°

Table 11-3 - Multi-master Defrost Example



# 12 Commissioning

## 12.1. Clock Setting and RTC Alarm Reset

If the clock is present: [EdF = rtC] enable the defrost from rtc [Ld1 to Ld6].



BEGIN		Press the up arrow key once to access the fast access menu.
Display	HM identify the clock RTC, press <b>SET</b>	
Display	<b>HUr</b> = hour -> press <b>SET</b> to save or change	
Display	<b>MIn</b> = minutes -> press <b>SET</b> to save or change	
	Do not use the other parameters if present.	
EXIT	<b>SET</b> + 	Press <b>SET</b> + up arrow keys for 10 seconds to reset the RTC alarm.

Table 12-1 - Clock Setting and RTC Alarm Reset

**NOTE:** The rtc clock menu is present also on the second level parameters.



**CAUTION!** If the board displays the rtF alarm, it means that the board must be replaced.

## 12.2. Electronic Valve Settings

The following parameters needs to be checked:

**[1] Superheat temperature probe:** NtC, PtC, Pt1000 with parameter **P6C**. The sensor has to be fixed at the end of the evaporator.

**[2] Pressure transducer:** [4 to 20mA] or ratio-metric **P5C = 420** or **5Vr** with parameter **P5C**.

**[3] Range of measurement:** Check the conversion parameters, **PA4** and **P20**, that are related to the transducer.

**TRANSDUCER:** For [-0.5/7Bar] or [0.5/8Bar abs], the correct setup is relative pressure with **PA4** = -0.5 and **P20**=7.0. For [0.5/12Bar abs], the correct setup is relative pressure with **PA4** = -0.5 and **P20** =11.00.

Example or virtual pressure with unique [4 to 20mA] or [0-5V] transducer:

Parameter	XM6x8D_1 w/o transducer	XM6x8D_2 + with transducer	XM6x8D_3 + w/o transducer
Adr	n	n+1	n+2
LPP	LPP = n	LPP=Y	LPP = n
P5C	LAN or probe not connected	P5C=420 or 0-5V	LAN or probe not connected
PA4	not used	-0.5 bar	not used
P20	not used	11.0 bar	not used

Table 12-2 - Example or virtual pressure with unique 4-20mA or 0-5V transducer

**[4] From the EEV submenu:** Select the correct kind of gas with the **FTy** parameter.

**[5]** Use the following parameters to set up the correct valve drive (based on the valve data sheet of the manufacturer).

# 13 Regulation for Superheat: Self Adaptive or Manual Operating Mode

## 13.1. General Considerations: Self Adaptive or Manual SH Control

The controller can regulate the superheat in manual or self adaptive mode, according to the value of the parameter **AMS**, **auto-tuning enabling**.

- With **AMS = n**: the normal SH regulation is performed.
- With **AMS = y**: the self adaptive SH regulation is performed.

## 13.2. Manual Operating Mode - AMS = NO

The temperature and SH regulation can be performed in two ways, according to the value of the parameter **CrE**: on/off or continuous. See the Standard temperature regulation in details below.

### 13.2.1. ON/OFF Temperature Regulation [CrE = n]

1. Temperature regulation is ON/OFF and it depends on the Setpoint and **HY** parameter (differential). Valve is closed when the temperature reaches the setpoint and open when the temperature is higher than setpoint + differential.
2. The superheat is regulated to be closer to its setpoint.
3. With more pauses normally also the humidity is higher.
4. Regulation pauses can be realized using the **Sti** and **Std** parameters (during these pauses the valve is closed).

### 13.2.2. Continuous Temperature Regulation [CrE = Y] (With Superheat Regulation)

1. The **HY** parameter becomes the temperature band for PI control. A good default value is 5°C.
2. The regulation of injection is continuous and the cooling output is always ON. The ❄️ icon is always ON except for the defrost phase.
3. The superheat is regulated following the **SSH** parameter.
4. Regulation pauses can be realized using **Sti** and **Std** parameters (during these pauses the valve is closed).
5. Increasing the **Int** integral time can decrease the speed of reaction of the regulator on the **HY** band.

## 13.3. Self Adaptive Operating Mode - AMS = YES

Auto-adaptive means to find and maintain the condition of the lowest super heating according to the load and environmental conditions present in a given time on the evaporator.

The parameter **ATU** enables the self adaptive mode in the superheat regulation.

In this functioning the values of **Pb** and **inC** parameter are automatically set by the controller according to the kind of applications and the response of the system.

With the **ATU = YES**, **CrE** must be set to **NO**.

The **self adaptive algorithm** does not affect the functions related to the forced opening of the valve in special situations, such as:

- **Forced opening of the valve at start of regulation**, parameter **SFd** (percentage) and **SFd** (time).
- **Forced opening of the valve after defrost**, parameter **oPd** (percentage) and **Pdd** (time).

## 13.4. Minimum Stable Superheat Search - AMS = YES, ATU = YES

With the parameter **ATU**, the minimum stable superheat search function is enabled.

With **ATU = yES**, controllers start searching the minimum stable value for the SH. The minimum admitted value in any case is **LSH + 2°C (4°F)**. Take this into consideration before setting the **LSH** value.

## 13.5. Valve Capacity Reducing - MnF Parameter

It is recommend to use the properly sized valve. In case fine tuning is required, the **MnF** parameter allows fine tuning of the valve to its evaporator.

The regulation band is not affected from the modification of the **MnF** parameter.

See the figure below (**Figure 13-1**) for the behavior of the capacity of the valve, when the **MnF** parameter is adjusted.

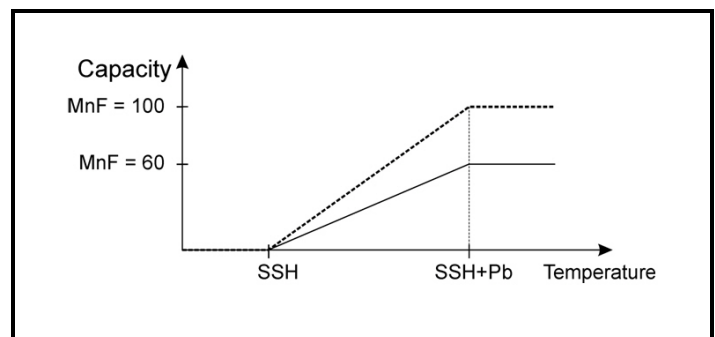

Figure 13-1 - Capacity of Valve in Adjusted MnF Parameter



**NOTE:** During the soft start phase (oPE, SFd), MnF parameter is not taken into consideration and the capacity of the valve is set by the parameters oPE and oPd, respectively.

## 13.6. Pressure Filtering- AnP Parameter

For a good SH regulation, it is important to use a filtered value of the pressure.

This can be done by the parameter AnP.

Suggested values:

- From 1-5 evaporators for each racks: AnP = 5-6
- From 6-30 evaporators for each racks: AnP = 3-4
- More than 30 evaporators for each racks: AnP = 2-3

# 14 Display Messages

	Display	Causes	Notes
<b>KEYBOARD</b>			
1	<b>nod</b>	No display: the keyboard is trying to work with another board that is not working or not present	Press for three (3) seconds the up arrow, enter the <b>SEC</b> menu and select <b>LOC</b> entry.
2	<b>Pon</b>	Keyboard is unlocked	
3	<b>PoF</b>	Keyboard is locked	
4	<b>rSt</b>	Alarm reset	Alarm output deactivated.
5	<b>noP, nP nA</b>	Not present (configuration) Not available (evaluation)	
6	<b>noL</b>	The keyboard is not able to communicate with the XM669K or XM678D	Verify the connection or call Emerson Technical Service.
<b>ALARM FROM PROBE INPUT</b>			
6	<b>P1 P2 P3 P4 P5 P6 PPF CPF</b>	Sensor brake down, value out of range or sensor incorrectly configured <b>P1C, P2C</b> to <b>P6C</b> .  <b>PPF</b> can be showed by slaves of pressure that do not receive the value of pressure.  <b>CPF</b> is showed when the remote probe 4 is not working.	<b>P1</b> : the cooling output works with <b>Con</b> and <b>COF</b> ,  With defrost probe on error the defrost is performed only at interval.  For <b>P5, P6</b> and <b>PPF</b> : the percentage of the valve opening is fixed at <b>PEO</b> value.
<b>TEMPERATURE ALARM</b>			
7	<b>HA</b>	Temperature alarm from parameter <b>ALU</b> on probe <b>rAL</b> .	Outputs unchanged.
8	<b>LA</b>	Temperature alarm from parameter <b>ALL</b> on probe <b>rAL</b> .	Outputs unchanged.
9	<b>HA2</b>	Second high temperature alarm.	Output depends on setting.
10	<b>LA2</b>	Second low temperature alarm.	Output depends on setting.
<b>DIGITAL INPUT ALARM</b>			
13	<b>dA</b>	Door open alarm from input <b>i1F, i2F</b> or <b>i3F</b> = after delay <b>d1d, d2d</b> or <b>d3d</b> .	Cooling relay and fan follow the <b>odc</b> parameter. Cooling restarts as specified on <b>rrd</b> parameter.
14	<b>EA</b>	Generic alarm from digital input <b>i1F, i2F, i3F</b> = <b>EAL</b> .	
15	<b>CA</b>	Severe alarm of regulation lock from digital input <b>i1F, i2F, i3F</b> = <b>bAL</b> .	Regulation output OFF.
16	<b>PAL</b>	Pressure switch lock <b>i1F, i2F</b> or <b>i3F</b> = <b>PAL</b> .	All the outputs are OFF.
<b>ELECTRONIC VALVE ALARM</b>			
17	<b>LOP</b>	Minimum operating pressure threshold from <b>LOP</b> parameter.	The valve output increases its opening of <b>dML</b> quantity every second.
18	<b>MOP</b>	Maximum operating pressure threshold from <b>MOP</b> parameter.	The valve output decreases its opening of <b>dML</b> quantity every second.
19	<b>LSH</b>	Low superheating from <b>LSH</b> parameter and <b>SHd</b> delay.	The valve will be closed; the alarm will be displayed after <b>SHd</b> delay.

Table 14-1 - Display Messages

	Display	Causes	Notes
20	HSH	High superheating from <b>HSH</b> parameter and <b>SHd</b> delay.	Only display.
<b>CLOCK ALARM</b>			
21	rtC	Clock settings lost.	Defrost will be performed with <b>IdF</b> until restoring the settings of RTC.
22	rtF	Clock damaged.	Defrost will be performed with <b>IdF</b> .
<b>OTHERS</b>			
23	EE	EEPROM serious problem.	Output OFF.
24	Err	Error with upload/download parameters.	Repeat the operation.
25	End	Parameters have been correctly transferred.	
26	dEF	Defrost is in progress	
27	cLn	Cleaning function is active	

Table 14-1 - Display Messages

## 14.1. Alarm Recovery

Probe alarms **P1**, **P2**, **P3**, and **P4** start some seconds after the fault in the related probe; they automatically stop some seconds after the probe restarts normal operation. Check the connections before replacing the probe.

Temperature alarms **HA**, **LA**, **HA2**, and **LA2** automatically stop as soon as the temperature returns to normal values.

Alarms **EA** and **CA** (with **i1F = bAL**) recover as soon as the digital input is disabled. Alarm **CA** (with **i1F = PAL**) recovers only by switching OFF and ON the device.

# 15 Electronic Expansion Valve Menu (For XM678D Only)

	<ol style="list-style-type: none"> <li>1. Enter the Programming mode by pressing the <b>SET</b> and DOWN keys for a few seconds (measurement unit starts blinking).</li> <li>2. Press the arrow until instrument shows EEU label.</li> <li>3. Press <b>SET</b>, to enter the EEV function menu.</li> </ol>
---	--

Table 15-1 - Commands

# 16 Controlling Loads

## 16.1. Temperature Probe Reference for Regulation

Up to 5 temperature probe can be used for the temperature regulation. It is possible to set the probes used for temperature regulation. Up to 5 Temperature inputs Pb1, Pb2, Pb3, Pb4, Pb6, can be used.

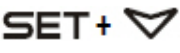
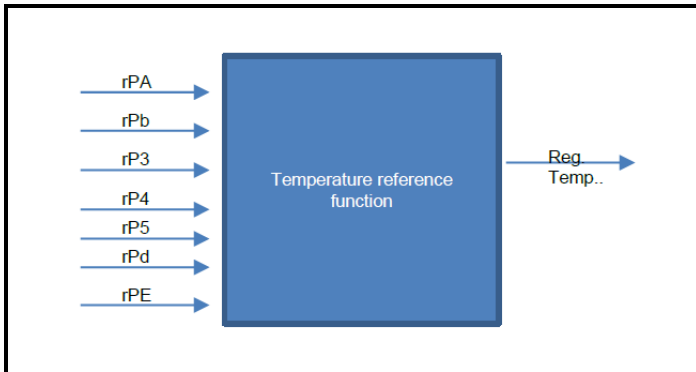

Figure 16-1- Control With Analog Output

To support above function, the parameters rPA, rPb, rP3, rP4, rP5 are used. Which combined temperature probe methods is set by par. rPd among the following: Average, Minimum, Maximum, First, or Mix.

**rPd = Avr** Average – Average of all valid probes defined as Regulation Probe by par. (rPA, rPb, rP3, rP4, rP5)

**rPd = Min** Minimum – Minimum of all valid probes defined as Regulation Probe by par. (rPA, rPb, rP3, rP4, rP5)

**rPd = MAS** Maximum – Maximum of all valid probes defined as Regulation Probe by par. (rPA, rPb, rP3, rP4, rP5)

**rPd = FrS** First – First valid probe defined as Regulation Probe by par. (rPA, rPb, rP3, rP4, rP5)

**rPd = rPE** Mix – This is currently done with “rPE” parameter.

### 16.1.1. Sensor Failure

In case of multiple temperature sensor regulation: (rPd = Aur, Min, Max or rPE), and with sensor failure, the remaining sensors are used for the regulation.

In case of an all sensors failure, the valve opens at PEO percentage

## 16.2. Dual Temp Mode Operation

Controller can have up to 4 pre-set regulations.

The preset regulation is set in the parameter MAP.

By digital input or supervising system is possible to enable the second regulation mode, set in the parameter M2P.

In this way a dual temp case can be easily set and controlled.

### 16.2.1. Second Map Function by Digital Input Configuration

By setting on digital input among i1F, i2F, i3F as the “nt” the map set in the parameter M2P is loaded when the digital input is enabled.

## 16.3. The Solenoid Valve

The regulation is performed according to the temperature measured by the thermostat probe that can be physical probe or virtual probe obtained by a weighted average between two probes (see parameters table description) with a positive differential from the setpoint. If the temperature increases and reaches setpoint plus differential, the solenoid valve is opened and then closed when the temperature reaches the setpoint value again.

In case of fault in the thermostat probe the opening and closing time of solenoid valve is configured by “Con” and “CoF” parameters.

## 16.4. Standard Regulation and Continuous Regulation

The regulation can be performed in two ways: the goal of the first method (**standard regulation**) is reaching the best superheat via a classic temperature regulation obtained using hysteresis. The second method, permits use of the valve to realize an high performance temperature regulation with a good factor of superheat precision. **This second possibility, it can be used only in centralized plants and it is available only with electronic expansion valve** by selecting CrE=Y parameter.

### 16.4.1. First Kind of Regulation:

In this case, the **Hy** parameter is the differential for standard ON/OFF regulation. During this phase the valve will maintain the SH setpoint.

### 16.4.2. Second Kind of Regulation – Continuous Regulation:

In this case, the **Hy** parameter is the proportional band of PI in charge of room temperature regulation and recommended to use at least **Hy = 5.0°C/10°F**. The **int** parameter is the integral time of the same PI regulator. Increasing **int** parameter the PI regulator become slow in reaction and is true vice versa. To disable the integral part of regulation, set **int = 0**.

## 16.5. Pump Down Before Defrost

The following parameters has been added:

**Pdt** pump down type (nu; FAn; F-C)

With **Pdt = nu**, the pump down is not enabled.

With **Pdt = Fan**, when a defrost trigger is given:

- a. Compressor relay will be open.

- b. EEV valve (if present):
  - i. Will be closed with CrE = n, y
  - ii. Will be open with CrE =EUP or EU5
- c. Fan will be forced on for Pdn time

With **Pdt = F-C**, when a defrost trigger is given:

- a. EEV valve (if present):
  - i. Will be closed with CrE = n, y
  - ii. Will be open with CrE =EUP or EU5
- b. Compressor relay and Fan will be forced on for Pdn time

**Pdn** pump down duration (0 to 255 minutes)

## 16.6. Defrost

### 16.6.1. Defrost Starting

**In any case, the device checks the temperature that is read by the configured defrost probe before starting the defrost, after that:**

- (If RTC is present) Two defrost modes are available through the **tdF** parameter: defrost with electrical heater and hot gas defrost. The defrost interval is controlled by the parameter **EdF**: (**EdF = rtC**) defrost is made in real time depending on the hours set in the parameters **Ld1** to **Ld6** in workdays and in **Sd1** to **Sd6** on holidays; (**EdF = in**) the defrost is made every **ldF** time.
- Defrost cycle starting can be operated locally (manual activation by means of the keyboard or digital input or end of interval time) or the command can come from the master defrost unit of the LAN. In this case, the controller will operate the defrost cycle following the parameters it has programmed. At the end of the drip time, it will wait until all the other controllers of the LAN finish their defrost cycle before restarting the normal regulation of the temperature according to **dEM** parameter.
- Each time any of the LAN controller begins a defrost cycle, it issues the command into the network making all the other controllers start their own cycle. This allows a perfect synchronization of the defrost in the whole multiplexed cabinet according to the **LMd** parameter.
- **Differential defrost:** Selecting the **dPA** and **dPb** probes and by changing the **dtP** and **ddP** parameters, the defrost can be started when the difference between **dPA** and **dPb** probes is lower than **dtP** for all **ddP** time. This is useful to start defrost when a low thermal exchange is detected. If [**ddP = 0**], this function is disabled.

### 16.6.2. Minimum Defrost Time

The “**ndt**” (0 to MnF) Minimum Defrost Time, set the minimum defrost duration, when the defrost is ended by evaporator temperature probe.

The **ndt** time is taken in account every time the defrost is triggered, independently from the value of end defrost temperature probe and end defrost digital input status.

### 16.6.3. Defrost Ending

- When defrost is started via **rtC**, the maximum defrost duration is obtained from the **Md** parameter and the defrost end temperature is obtained from the **dtE** parameter (and **dtS** if two defrost probes are selected).
- If **dPA** and **dPb** are present and [**d2P = Y**], the device stops the defrost procedure when **dPA** is higher than **dtE** temperature and **dPb** is higher than **dtS** temperature.

At the end of defrost, the drip time is controlled through the **Fdt** parameter.

### 16.6.4. Kind of Defrost

The kind of defrost is set by parameter **tdF** among the following possibilities.

**tdF = Air: natural defrost.** Defrost is made by opening the compressor/solenoid relay. The fan during defrost depends on the parameter **Fnc**. Defrost relay is Off. The valve is closed.

**tdF = EL: defrost with electrical heater:** Defrost is made by opening the compressor/solenoid relay. The fan during defrost depends on the parameter **Fnc**. Defrost relay is ON. The valve is closed.

**tdF = in: hot gas defrost.** Defrost is made by closing the compressor/solenoid relay. The fan during defrost depends on the parameter **Fnc**. Defrost relay is ON. The valve opening percentage during the defrost is set by the par. **oPd**.

## 16.7. On Demand Defrost

### 16.7.1. Description

Controllers can perform on demand defrost. It is based on the behavior of evaporator temperature.

Controllers monitor the evaporator temperature and triggers a defrost if some conditions are satisfied. For defrost efficiency it is important to place the “end defrost probe,” usually P2, in the coldest place of the evaporator, usually immediately after the expansion valve.

**NOTE:** *Because of different types of evaporators and consequentially behaviors, it is recommended to test and validate this algorithm in a climatic chamber before applying it in the field.*



## 16.7.2. Parameters and Settings

The On Demand Defrost can be activated with the following settings: CrE="n", EdF="Aut"

**cdt: evaporator temperature differential to trigger a defrost** (default cdt = 4°K).

**nbd: minimum compressor run before automatic defrost** (or minimum time of activation of solenoid valve) It must be set properly. It prevents defrost from starting (default nbd = 4.0 hours).

**Mbd: max compressor run before automatic defrost** (or max time of activation of solenoid valve) It must be set properly. If reached, a defrost is triggered (default Mbd = 16.0 hours).

**nct: minimum evap. temperature**, it must be set properly. A defrost is triggered when this temperature is reached (default nct = -30°C).

**NOTE:** With CrE="y" or CrE="EUP" or CrE=EU5 only «RTC defrost» and «interval defrost» are allowed. With EdF="Aut" & CrE="y" or CrE="EUP" or CrE=EU5 the «interval defrost» will be performed, as with EdF = in.

## 16.7.3. Exceptions

1. A defrost cannot be triggered if the compressor has not run more than minimum time (*nbd* parameter) since the last defrost or initial power up. (Resolution hh.m)
2. If the compressor has run for more than maximum time since the last defrost or initial power up (*Mbd* parameter), a defrost is triggered regardless of coil temperature.
3. If the coil temperature reaches very low temperature, (*nct* parameter), a defrost is triggered regardless of *cdt* value.

## 16.8. Fans

### 16.8.1. Control with Relay

The fan control mode is selected by means of the **FnC** parameter:

- **C-n** = Running with the solenoid valve, OFF during defrost
- **C-Y** = Running with the solenoid valve, ON during defrost
- **O-n** = Continuous mode, OFF during defrost
- **O-Y** = Continuous mode, ON during defrost

An additional parameter **FSt** provides the setting of the temperature, detected by the evaporator probe, above which the fans are always OFF. This can be used to verify that air is circulated only if this temperature is lower than set in the **FSt**.

### 16.8.2. Control With Analog Output (If Present)

The modulating output [**trA = rEG**] works in a proportional manner (excluding the first **AMt** seconds where the fans speed is the maximum; 10 seconds is the minimum value).

The regulation setpoint is relative to the regulation setpoint and is indicated by **ASr**, the proportional band is always located above the [**SET + ASr**] value and its value is **PbA**. The fans are at minimum speed **AMi** when the temperature read by the fan probe is [**SET + ASr**] and the fan is at maximum speed (**AMA**) when the temperature is [**SET + ASr + PbA**].

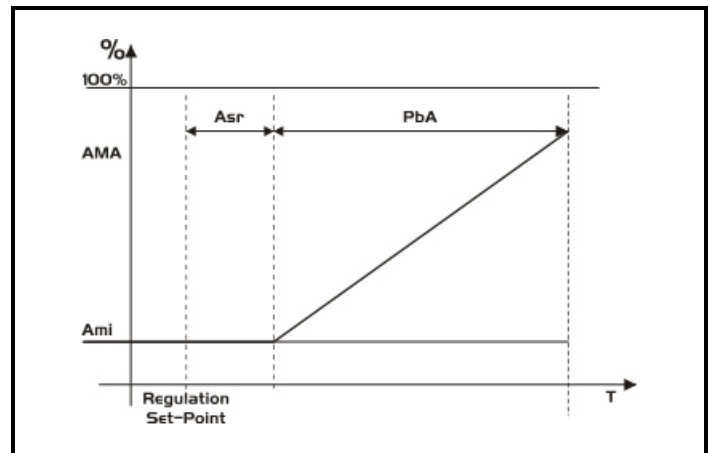

Figure 16-2 - Control With Analog Output

## 16.9. Anti-Sweat Heaters

Anti-sweat heater regulation can be performed with the on board relay (if **OA6 = AC**) or with the analog output (if present by setting **trA = AC**). However, the regulation can be performed in two ways:

- Without real dewpoint information: in this case the default value for dewpoint is used (**SdP** parameter).
- Receiving dewpoint from **XWEB5000** system: the **SdP** parameter is overwritten when a valid value for dewpoint is received from XWEB. In case the XWEB link is lost, **SdP** is the value that will be used for safety.

The best performance can be obtained using probe 4. In this case, the regulation follows the chart illustrated in **Figure 16-3**:

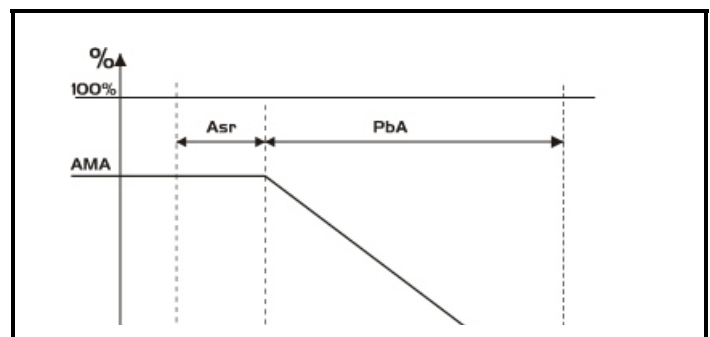

Figure 16-3 - Anti-Sweat Heaters

**Probe 4 should be placed on the showcase glass.** For each cabinet, only one probe 4 (P4) can be used; the P4 will send its value to the other sections that are connected to the LAN.

## Functioning with Probe 4 within the LAN:

Parameter	XM6x8D_1 Without Probe 4	XM6x8D_2 + With Probe 4	XM6x8D_3+ Without Probe 4
Adr	n	n + 1	n + 2
LCP	LCP = n	LCP = Y	LCP = n
P4C	LAN or probe not connected	P4C = NTC, PtC or PtM	LAN or probe not connected
trA	trA = AC if the device has the analog output		
OA6	OA6 = AC if the device will use the AUX relay for regulation		

Table 16-1 - Functioning with Probe 4 within the LAN

## Functioning Without Probe 4:

Parameter	XM6x8D Without Probe 4
P4C	nP
AMt	% of ON

Table 16-2 - Functioning Without Probe 4

In this case, regulation is performed by switching the auxiliary relay ON and OFF on a 60-minutes time base. The ON time will be the **AMt** value, so that the relay will be ON for **AMt** minutes and OFF for [**60-AMt**] minutes.

In case of P4 error or if P4 is absent, the output is at **AMA** value for the **AMt** time then the output is at **0** value for the time [**255 - AMt**] time performing a simple PWM modulation.

## 16.10. Cleaning Mode Function by Digital Input Configuration

The “cLn” value is added to the functions of the digital input.

The function has the same basic features of the standby function, but with the following differences:

- By the parameter **LcL** (No, Yes) it is possible to set if the light is ON or OFF during cleaning mode. This parameter **LcL** can be overridden by light button or by Light on/off MODBUS command.
- By the parameter **FcL** (No, Yes) it is possible to set if the fan is on or off during cleaning mode. If the fan is ON, the **FSt** parameter (fan stop temperature) is overridden.

### 16.10.1. Display

During the Cleaning Status, the display shows the “cLn” message.

## 16.11. Auxiliary Output

The auxiliary output is switched ON and OFF by means of the corresponding digital input or by pressing and releasing the down arrow key.

# 17 Parameter List

Parameter	Description
<b>REGULATION</b>	
Set	<b>Temperature setpoint</b> (LS to US)
rtC	<b>Access to CLOCK submenu (if present)</b>
EEU	<b>Access to EEV submenu (only XM678D)</b>
Hy	<b>Differential:</b> (0,1 to 25,5°C; 1 to 45°F): Intervention differential for setpoint, always positive. Solenoid valve Cut IN is Setpoint Plus Differential (Hy). Solenoid valve Cut OUT is when the temperature reaches the setpoint.
Int	<b>Integral time for room temperature regulation (Only XM678D):</b> (0 to 255 seconds) Integral time for room temperature PI regulator. 0= no integral action.
CrE	<b>Continuous regulation activation (Only XM678D):</b> (N to Y) N= standard regulation; Y= continuous regulation. Use it only in centralized plants.
LS	<b>Minimum setpoint limit:</b> (-55.0°C to SET; -67°F to SET) Sets the minimum acceptable value for the setpoint.
US	<b>Maximum setpoint limit:</b> (SET to 150°C; SET to 302°F) Set the maximum acceptable value for setpoint.
Ods	<b>Outputs activation delay at start up:</b> (0 to 255 minutes) This function is enabled at the initial start up of the instrument and inhibits any output activation for the period of time set in the parameter. (AUX and Light can work)
AC	<b>Anti-short cycle delay:</b> (0 to 60 minutes) Interval between the solenoid valve stop and the following restart.
CCt	<b>Compressor ON time during continuous cycle:</b> (0.0 to 24.0 hours; resolution 10 minutes) Allows to set the length of the continuous cycle: compressor stays on without interruption for the CCt time. Can be used, for instance, when the room is filled with new products.
CCS	<b>Setpoint for continuous cycle:</b> (-55 to 150°C / -67 to 302°F) It sets the setpoint used during the continuous cycle.
Con	<b>Solenoid valve ON time with faulty probe:</b> (0 to 255 minutes) Time during which the solenoid valve is active in case of faulty thermostat probe. With CO <sub>n</sub> = 0 solenoid valve is always OFF.
CoF	<b>Solenoid valve OFF time with faulty probe:</b> (0 to 255 minutes) Time during which the solenoid valve is OFF in case of faulty thermostat probe. With CO <sub>F</sub> = 0 solenoid valve is always active.
<b>DISPLAY</b>	
CF	<b>Temperature measurement unit: °C= Celsius; °F= Fahrenheit.</b> <b>WARNING:</b> When the measurement unit is changed, the parameters with temperature values have to be checked.
PrU	<b>Pressure mode:</b> (rEL or Abs) It defines the mode to use the pressure. <b>WARNING:</b> The setting of PrU is used for all the pressure parameters. If PrU=rEL all pressure parameters are in relative pressure unit, if PrU=Abs all pressure parameters are in absolute pressure unit. <b>(Only XM678D)</b>
PMU	<b>Pressure measurement unit:</b> (bAr – PSI - MPA) It selects the pressure measurement units. MPA= the value of pressure measured by kPA * 10. <b>(Only XM678D)</b>
PMd	<b>Way of displaying pressure:</b> (tEM - PrE) It permits showing the value measured by pressure probe with tEM= temperature or by PrE= pressure; <b>(Only XM678D)</b>
rES	<b>Resolution (for °C):</b> (in = 1°C; dE = 0.1 °C) Allows decimal point display.
rEP	<b>Resolution for % value:</b> (in = integer; dE = with decimal point) Allows decimal point display for percentage values.
Lod	<b>Instrument display:</b> (nP; P1; P2, P3, P4, P5, P6, tEr, dEF) It selects which probe is displayed by the instrument. <b>P1, P2, P3, P4, P5, P6, tEr</b> = virtual probe for thermostat, <b>dEF</b> = virtual probe for defrost.

Table 17-1 - Parameter List

Parameter	Description
rEd	<b>Remote display:</b> (nP; P1; P2, P3, P4, P5, P6, tEr, dEF) It selects which probe is displayed by the X-REP. <b>P1, P2, P3, P4, P5, P6, tEr</b> = virtual probe for thermostat, <b>dEF</b> = virtual probe for defrost.
dLy	<b>Display delay:</b> (0 to 24.0 minutes; resolution 10 seconds) When the temperature increases, the display is updated of 1 °C/1°F after this time.
rPA	<b>Regulation probe A:</b> (nP; P1; P2, P3, P4, P6) First probe used to regulate room temperature. If rPA =nP the regulation is performed with real value of rPb.
rPb	<b>Regulation probe B:</b> (nP; P1; P2, P3, P4, P5) Second probe used to regulate room temperature. If rPb = nP the regulation is performed with real value of rPA.
rP3	<b>Regulation probe 3:</b> (nP; P1; P2, P3, P4, P6) Third probe used to regulate room temperature, with rPd = Aur or Min or MA or FrS.
rP4	<b>Regulation probe 4:</b> (nP; P1; P2, P3, P4, P6) Fourth probe used to regulate room temperature, with rPd = Aur or Min or MA or FrS.
rP5	<b>Regulation probe 5:</b> (nP; P1; P2, P3, P4, P6) Fifth probe used to regulate room temperature, with rPd = Aur or Min or MA or FrS.
rPd	<b>Temperature Regulation Strategy:</b> (Aur, Min, MAS, FrS, rPE) <b>Aur:</b> Average of all valid probes defined as Regulation Probe <b>Min:</b> Minimum value of all valid probes defined as Regulation Probe <b>MaS:</b> Maximum of all valid probes defined as Regulation Probe <b>FrS:</b> First valid probe defined as Regulation Probe <b>rPE:</b> Mix between rPA and rPb defined by rPE parameter
rPE	<b>Regulation virtual probe percentage:</b> (0 to 100%) It defines the percentage of the rPA respect to rPb. The value used to regulate room temperature is obtained by: $Value\_for\_room = (rPA * rPE + rPb * (100 - rPE)) / 100$

Table 17-1 - Parameter List

Parameter	Description																																																																					
<b>ELECTRONIC EXPANSION VALVE SUBMENU (Only XM678D)</b>																																																																						
<b>FtY</b>	Kind of gas:																																																																					
	<table border="1" style="width: 100%; border-collapse: collapse;"> <thead> <tr> <th style="text-align: center;">LABEL</th> <th style="text-align: center;">REFRIGERANT</th> <th style="text-align: center;">OPERATING RANGE</th> </tr> </thead> <tbody> <tr><td style="text-align: center;">R22</td><td>r22</td><td style="text-align: center;">-58 to 120°F / -50 to 60°C</td></tr> <tr><td style="text-align: center;">134</td><td>r134A</td><td style="text-align: center;">-58 to 120°F / -50 to 60°C</td></tr> <tr><td style="text-align: center;">290</td><td>r290 – Propane</td><td style="text-align: center;">-58 to 120°F / -50 to 60°C</td></tr> <tr><td style="text-align: center;">404</td><td>r404A</td><td style="text-align: center;">-94 to 120°F / -70 to 60°C</td></tr> <tr><td style="text-align: center;">47A</td><td>r407A</td><td style="text-align: center;">-58 to 120°F / -50 to 60°C</td></tr> <tr><td style="text-align: center;">47C</td><td>r407C</td><td style="text-align: center;">-58 to 120°F / -50 to 60°C</td></tr> <tr><td style="text-align: center;">47F</td><td>r407F</td><td style="text-align: center;">-58 to 120°F / -50 to 60°C</td></tr> <tr><td style="text-align: center;">410</td><td>r410A</td><td style="text-align: center;">-58 to 120°F / -50 to 60°C</td></tr> <tr><td style="text-align: center;">448</td><td>r448A</td><td style="text-align: center;">-49 to 120°F / -45 to 60°C</td></tr> <tr><td style="text-align: center;">449</td><td>r449A</td><td style="text-align: center;">-49 to 120°F / -45 to 60°C</td></tr> <tr><td style="text-align: center;">450</td><td>r450A</td><td style="text-align: center;">-49 to 120°F / -45 to 60°C</td></tr> <tr><td style="text-align: center;">452</td><td>r452A</td><td style="text-align: center;">-94 to 120°F / -70 to 60°C</td></tr> <tr><td style="text-align: center;">507</td><td>r507</td><td style="text-align: center;">-94 to 120°F / -70 to 60°C</td></tr> <tr><td style="text-align: center;">513</td><td>r513A</td><td style="text-align: center;">-49 to 120°F / -45 to 60°C</td></tr> <tr><td style="text-align: center;">CO2</td><td>r744 - Co2</td><td style="text-align: center;">-58 to 77°F / -50 to 25°C</td></tr> <tr><td style="text-align: center;">15b</td><td>r515b</td><td style="text-align: center;">-22 to 120°F / -30 to 60°C</td></tr> <tr><td style="text-align: center;">54A</td><td>r454A</td><td style="text-align: center;">-58 to 120°F / -50 to 60°C</td></tr> <tr><td style="text-align: center;">54b</td><td>r454B</td><td style="text-align: center;">-58 to 120°F / -50 to 60°C</td></tr> <tr><td style="text-align: center;">54C</td><td>r454C</td><td style="text-align: center;">-58 to 120°F / -50 to 60°C</td></tr> <tr><td style="text-align: center;">55A</td><td>r455A</td><td style="text-align: center;">-40 to 120°F / -40 to 60°C</td></tr> <tr><td style="text-align: center;">4yF</td><td>r1234yf</td><td style="text-align: center;">-58 to 120°F / -50 to 60°C</td></tr> <tr><td style="text-align: center;">4EE</td><td>r1234ze</td><td style="text-align: center;">-58 to 120°F / -50 to 60°C</td></tr> </tbody> </table>	LABEL	REFRIGERANT	OPERATING RANGE	R22	r22	-58 to 120°F / -50 to 60°C	134	r134A	-58 to 120°F / -50 to 60°C	290	r290 – Propane	-58 to 120°F / -50 to 60°C	404	r404A	-94 to 120°F / -70 to 60°C	47A	r407A	-58 to 120°F / -50 to 60°C	47C	r407C	-58 to 120°F / -50 to 60°C	47F	r407F	-58 to 120°F / -50 to 60°C	410	r410A	-58 to 120°F / -50 to 60°C	448	r448A	-49 to 120°F / -45 to 60°C	449	r449A	-49 to 120°F / -45 to 60°C	450	r450A	-49 to 120°F / -45 to 60°C	452	r452A	-94 to 120°F / -70 to 60°C	507	r507	-94 to 120°F / -70 to 60°C	513	r513A	-49 to 120°F / -45 to 60°C	CO2	r744 - Co2	-58 to 77°F / -50 to 25°C	15b	r515b	-22 to 120°F / -30 to 60°C	54A	r454A	-58 to 120°F / -50 to 60°C	54b	r454B	-58 to 120°F / -50 to 60°C	54C	r454C	-58 to 120°F / -50 to 60°C	55A	r455A	-40 to 120°F / -40 to 60°C	4yF	r1234yf	-58 to 120°F / -50 to 60°C	4EE	r1234ze	-58 to 120°F / -50 to 60°C
	LABEL	REFRIGERANT	OPERATING RANGE																																																																			
	R22	r22	-58 to 120°F / -50 to 60°C																																																																			
	134	r134A	-58 to 120°F / -50 to 60°C																																																																			
	290	r290 – Propane	-58 to 120°F / -50 to 60°C																																																																			
	404	r404A	-94 to 120°F / -70 to 60°C																																																																			
	47A	r407A	-58 to 120°F / -50 to 60°C																																																																			
	47C	r407C	-58 to 120°F / -50 to 60°C																																																																			
	47F	r407F	-58 to 120°F / -50 to 60°C																																																																			
	410	r410A	-58 to 120°F / -50 to 60°C																																																																			
	448	r448A	-49 to 120°F / -45 to 60°C																																																																			
	449	r449A	-49 to 120°F / -45 to 60°C																																																																			
	450	r450A	-49 to 120°F / -45 to 60°C																																																																			
	452	r452A	-94 to 120°F / -70 to 60°C																																																																			
	507	r507	-94 to 120°F / -70 to 60°C																																																																			
	513	r513A	-49 to 120°F / -45 to 60°C																																																																			
	CO2	r744 - Co2	-58 to 77°F / -50 to 25°C																																																																			
	15b	r515b	-22 to 120°F / -30 to 60°C																																																																			
	54A	r454A	-58 to 120°F / -50 to 60°C																																																																			
54b	r454B	-58 to 120°F / -50 to 60°C																																																																				
54C	r454C	-58 to 120°F / -50 to 60°C																																																																				
55A	r455A	-40 to 120°F / -40 to 60°C																																																																				
4yF	r1234yf	-58 to 120°F / -50 to 60°C																																																																				
4EE	r1234ze	-58 to 120°F / -50 to 60°C																																																																				
<b>ATU</b>	<b>Self adaptive SH regulation enabling</b> (No; Yes) This parameter enables the self adaptive regulation of the superheat. <b>CrE = no must to be set, when this function is enabled.</b>																																																																					
<b>AMS</b>	<b>Minimum STABLE superheat search</b> (No; Yes) This parameter enables the search of the minimum stable superheat. The lowest admitted value is LSH+2°C.																																																																					
<b>SSH</b>	<b>Superheat setpoint:</b> [0.1°C to 25.5°C] [1°F to 45°F] it is the value used to regulate superheat																																																																					
<b>SHy</b>	<b>Differential for low superheat function:</b> This value is used by X-WEB with XeCO2 function. When the monitoring system enable the low superheat Shy is subtracted to the SSH setpoint (-12.0 to 12.0°C).																																																																					
<b>Pb</b>	<b>Proportional band:</b> (0.1 to 60.0 / 1 to 108°F) PI proportional band.																																																																					
<b>PbH</b>	<b>Dead band for superheat regulation:</b> It is a band across the SH setpoint, inside this band the valve opening percentage is not updated.																																																																					
<b>rS</b>	<b>Band Offset:</b> (-12.0 to 12.0°C / -21 to 21°F) PI band offset																																																																					
<b>inC</b>	<b>Integration time:</b> (0 to 255 seconds) PI integration time																																																																					
<b>dFC</b>	<b>Derivative time:</b> (0 to 255seconds) PID derivative time																																																																					
<b>PEd</b>	<b>Delay before stopping regulation with probe error:</b> 0 to 239 seconds - On (240)																																																																					
<b>PEO</b>	<b>Probe Error opening percentage:</b> (0 to 100%) If a probe error occurs, valve opening percentage is PEO.																																																																					

Table 17-1 - Parameter List

Parameter	Description
SFd	<b>Start Function duration:</b> (0.0 to 42.0 minutes: resolution 10 seconds) It sets start function duration and post-defrost duration. <b>During this phase the SH alarms are overridden.</b>
SFP	<b>Start opening Percentage:</b> (0 to 100%) Opening valve percentage when start function is active. This phase duration is <b>SFd time</b> .
OHg	<b>Opening Percentage during hot gas defrost:</b> (0 to 100%) Opening valve percentage when hot gas defrost is active.
Pdd	<b>Post Defrost Function duration:</b> (0.0 to 42.0 minutes: resolution 10 seconds) It sets start function duration and post-defrost duration. <b>During this phase the alarms are overridden.</b>
OPd	<b>Opening Percentage after defrost phase:</b> (0 to 100%) Opening valve percentage when after defrost function is active. This phase duration is <b>Pdd time</b> .
LnF	<b>Minimum opening percentage at normal Functioning:</b> (0 to 100%) During regulation it sets the minimum valve opening percentage; (0 to MnF%)
MnF	<b>Maximum opening percentage at normal Functioning:</b> (LnF to 100) During regulation it sets the maximum valve opening percentage.
dCL	<b>Regulation off delay, when the setpoint is reached</b> (0 to 255 seconds)
Fot	<b>Forced opening percentage:</b> (0 to 100% - nu) It permits to force the valve opening to the specified value. This value overwrite the value calculated by PID algorithm. <b>NOTE:</b> to obtain the correct superheat regulation you have to set $Fot=nu$ .
LPL	<b>Lower Pressure Limit for superheat regulation:</b> (PA4 to P20 bar / psi / <b>kPA * 10</b> ) When suction pressure comes down to LPL the regulation is performed with a LPL fixed value for pressure, when pressure comes back to LPL the normal pressure value is used. (related to PrM parameter)
MOP	<b>Maximum Operating Pressure threshold:</b> (PA4 to P20 bar / psi / <b>kPA * 10</b> ) if suction pressure exceeds maximum operating pressure value, instrument signals situation with MOP alarm. (related to PrM parameter)
dMP	<b>Delay for Maximum Operating Pressure threshold alarm signaling:</b> (0 to 255 seconds) When a MOP alarm occurs it is signaled after dMP time.
LOP	<b>Minimum Operating Pressure threshold:</b> (PA4 to P20 bar / psi / <b>kPA * 10</b> ) If the suction pressure comes down to this value a low pressure alarm is signaled with LOP alarm. (related to PrM parameter)
dLP	<b>Delay for Minimum Operating Pressure threshold alarm signaling:</b> (0 to 255 seconds) When a LOP alarm occurs it is signaled after dMP time
dML	<b>Opening steps variation during MOP and LOP:</b> (0 to 100%) When a MOP alarm occurs valve will close of the dML percentage every cycle period until MOP alarm is active. When LOP occurs valve will open of the dML percentage every cycle period until LOP alarm is active.
AAS	<b>Low superheat alarm with "XeCO2 function active:</b> N = no superheat alarm, Y= Low superheat alarm is still signaled.
HSH	<b>High Superheat alarm:</b> (LSH to 80.0°C / LSH to 144°F) When superheat exceeds this value an high superheat alarm is signaled after interval <b>SHd</b> .
LSH	<b>Low Superheat alarm:</b> (0.0 to HSH °C / 0 to HSH °F) When superheat goes down to this value a low superheat alarm is signaled after interval <b>SHd</b> .
dHS	<b>High superheat alarm activation delay:</b> (0.0 to 42.0 minutes: resolution 10 seconds) When a high superheat alarm occurs, the time dHS has to pass before alarm signaling.
dLS	<b>Low superheat alarm activation delay:</b> (0.0 to 42.0 minutes: resolution 10 seconds) When a low superheat alarm occurs, the time SHd has to pass before alarm signaling.
LSA	<b>Opening percentage decrease with low Superheat alarm:</b> (0 to 100%)
FrC	<b>Fast-recovery Constant:</b> (0 to 100 seconds) Permits to increase integral time when SH is below the setpoint. If <b>FrC = 0</b> fast recovery function is disabled.
AnP	<b>Pressure filter</b> (0 to 100) It uses the last average values of the pressure to calculate the superheat. <b>E.I.</b> with <b>AnP = 5</b> controller uses the average pressure in the last 5 seconds to calculate the SH. <b>NOTE:</b> Avoid values higher than 10

Table 17-1 - Parameter List

Parameter	Description																																																						
Ant	<b>Temperature filter</b> (0 to 100) It uses the last average values of the temperature to calculate the superheat. <b>E.I. with Ant = 5</b> controller uses the average temperature in the last 5 seconds to calculate the SH. <b>NOTE: Avoid values higher than 10</b>																																																						
SLb	<b>Reaction time</b> (0 to 255 seconds): time to update the valve open percentage. E.I. With SLb = 24: the valve open percentage is updated every 24 seconds.																																																						
tEP	<p><b>Predefined valve selection:</b> [0 to 10] if [tEP = 0] The user has to modify all the parameters of configuration in order to use the valve. If <b>tEP is different from 0</b> the device performs a fast configuration of the following parameters: <b>LSt, uSt, Sr, CPP, CHd</b>. To select the right number please read the following table.</p> <p>If <b>tEP is different from 0</b> previous configuration of <b>LSt, uSt, Sr, CPP and CHd</b> are <b>overwritten</b>.</p> <table border="1"> <thead> <tr> <th>tEP</th> <th>Model</th> <th>LSt (steps* 10)</th> <th>uSt (steps* 10)</th> <th>CPP (mA* 10)</th> <th>CHd (mA* 10)</th> <th>Sr (step/s)</th> <th>tEu (bip/unip)</th> <th>HSF (Half/Full)</th> </tr> </thead> <tbody> <tr> <td>0</td> <td>Manual settings</td> <td>Par</td> <td>Par</td> <td>Par</td> <td>Par</td> <td>Par</td> <td>Par</td> <td>Par</td> </tr> <tr> <td>1</td> <td>Danfoss EST-25/50</td> <td>7</td> <td>262</td> <td>10</td> <td>10</td> <td>300</td> <td>bP</td> <td>FUL</td> </tr> <tr> <td>2</td> <td>Danfoss EST-100</td> <td>10</td> <td>353</td> <td>10</td> <td>10</td> <td>300</td> <td>bP</td> <td>FUL</td> </tr> <tr> <td>3</td> <td>Danfoss EST-250/400</td> <td>11</td> <td>381</td> <td>10</td> <td>10</td> <td>300</td> <td>bP</td> <td>FUL</td> </tr> <tr> <td>11</td> <td>Emerson EX4/EX5/EX6</td> <td>5</td> <td>75</td> <td>50</td> <td>10</td> <td>300</td> <td>bP</td> <td>FUL</td> </tr> </tbody> </table>	tEP	Model	LSt (steps* 10)	uSt (steps* 10)	CPP (mA* 10)	CHd (mA* 10)	Sr (step/s)	tEu (bip/unip)	HSF (Half/Full)	0	Manual settings	Par	Par	Par	Par	Par	Par	Par	1	Danfoss EST-25/50	7	262	10	10	300	bP	FUL	2	Danfoss EST-100	10	353	10	10	300	bP	FUL	3	Danfoss EST-250/400	11	381	10	10	300	bP	FUL	11	Emerson EX4/EX5/EX6	5	75	50	10	300	bP	FUL
tEP	Model	LSt (steps* 10)	uSt (steps* 10)	CPP (mA* 10)	CHd (mA* 10)	Sr (step/s)	tEu (bip/unip)	HSF (Half/Full)																																															
0	Manual settings	Par	Par	Par	Par	Par	Par	Par																																															
1	Danfoss EST-25/50	7	262	10	10	300	bP	FUL																																															
2	Danfoss EST-100	10	353	10	10	300	bP	FUL																																															
3	Danfoss EST-250/400	11	381	10	10	300	bP	FUL																																															
11	Emerson EX4/EX5/EX6	5	75	50	10	300	bP	FUL																																															
tEU	<b>Type of Stepper motor:</b> [uP-bP] It permits to select the kind of valve. <b>uP</b> = 5 - 6 wires unipolar valves; <b>bP</b> = 4 wires bipolar valves; <b>NOTE: By changing this parameter the valve has to be reinitialized.</b>																																																						
bdM	<b>bipolar valve piloting:</b> ["UAM"(0=Wave Mode) - "noM"(1 = Normal Mode)] Bipolar valve pilot mode: Wave Mode - Normal Mode																																																						
HFS	<b>Kind of motor movement:</b> (HAF; FUL) <b>HAF</b> = Half step. Use this setting for the unipolar valve. <b>FUL</b> = Half step. Use this setting for the bipolar valve.																																																						
LSt	<b>Minimum number of steps:</b> [0 to USt] It permits to select the minimum number of steps. At this number of steps the valve should be closed. So it is necessary the reading of manufacturer data sheet to set correctly this parameter. It is the minimum number of steps to stay in advised range of functioning. <b>NOTE: By changing this parameter the valve has to be reinitialized. The device performs this procedure automatically and restarts its normal functioning when the programming mode ends.</b>																																																						
USt	<b>Maximum number of steps:</b> [LSt to 800* 10] it permits to select the maximum number of steps. At this number of steps the valve should be completely opened. Read the datasheet provided by the valve manufacturer to set this parameter correctly. It is the maximum number of steps to stay within the advised range of functioning. <b>WARNING: By changing this parameter the valve has to be reinitialized. The device performs this procedure automatically and restarts its normal functioning when the programming mode ends.</b>																																																						
Est	<b>Extra step during closing phase:</b> (0 to 255* 10) it sets the number of extra steps the controller performs, when the valve is closed at start up, and during the pauses of regulation, to force the closure of the valve. <b>NOTE: To set Est, follow these steps:</b> 1. Set the kind of valve by the parameter tEP. This pre-sets the parameters related to the valve 2. Set the correct value of Est																																																						

Table 17-1 - Parameter List



Parameter	Description
Sr	<b>Step rate</b> [10 to 600 step/second] It is the maximum speed to change step without losing precision (without losing steps). It is recommended to stay under the maximum speed.
CPP	<b>Current per phase (only bipolar valves):</b> [0 to 100*10mA] It is the maximum current per phase used to drive the valve. It is used <b>only with bipolar valves</b> .
CHd	<b>Holding current per phase (only bipolar valves):</b> [0 to 100*10mA] It is the current per phase when the valve is stopped for more than 4 minutes. It is used <b>only with bipolar valves</b> .
GtC	<b>Minimum Interval to enable calibration cycles with extra steps EST:</b> [0 to GtH hour]] Indicates the number of hours after which the valve calibration is enabled (with extra steps EST) when the regulation closes the valve at 0%.
GtH	<b>Interval between automatic valve calibration cycles:</b> [GtC to 255 (ore)]
dtY	<b>Pilot duty:</b> (20 to 100%) with dtY = 100, the valve is moved without interruption, with dtY = 60 the valve is moved with a pilot duty of 60%: for 0.6s on and then for 0.4s off until the final position is reached.
<b>DEFROST</b>	
dPA	<b>Defrost Probe A:</b> (nP; P1; P2, P3, P4, P6) First probe used for defrost. If rPA=nP the regulation is performed with real value of dPb.
dPb	<b>Defrost Probe B:</b> (nP; P1; P2, P3, P4, P6) Second probe used for defrost. If rPB=nP the regulation is performed with real value of dPA. <b>Value_for_defrost= (dPA * dPE + dPb * (100-dPE))/100</b>
tdF	<b>Defrost type:</b> (Air, EL, in) <b>Air</b> = Air defrost (relay is not switched on during defrost) <b>EL</b> = Defrost with electrical heater <b>in</b> = Hot gas defrost
EdF	<b>Defrost mode:</b> (rtc – in- Aut) ( <b>only if RTC is present</b> ) <b>rtc</b> = defrost activation via RTC; <b>in</b> = defrost activation with <b>idf</b> ; <b>Aut</b> = on demand defrost.
Srt	<b>Heater setpoint during defrost:</b> (-55.0 to 150.0°C; -67 to 302°F) if <b>tdF</b> = <b>EL</b> during the defrost the defrost relay perform an ON/OFF regulation with <b>Srt</b> as setpoint.
Hyr	<b>Differential for heater:</b> (0.1°C to 25.5°C, 1°F to 45°F) The differential for heater.
tod	<b>Time out for heater:</b> 0 to 255 (minutes) if the defrost probe temperature is bigger than <b>Srt</b> for all <b>tod</b> time the defrost ends although the defrost probe temperature is lower than dtE or dtS. It permits to reduce defrost duration.
d2P	<b>Defrost with two probes:</b> (N – Y) <b>N</b> = only the dPA probe is used to defrost management; <b>Y</b> = defrost is managed with <b>dPA</b> probe and <b>dPb</b> probe. Defrost can performed only if both probe values are lower than dtE for dPA probe and dtS for dPb probe.
dtE	<b>Defrost termination temperature (Probe A):</b> (-55, 0 to 50, 0°C; -67 to 122°F) (Enabled only when the evaporator probe is present) sets the temperature measured by the evaporator probe <b>dPA</b> , which causes the end of defrost.
dtS	<b>Defrost termination temperature (Probe B):</b> (-55, 0 to 50, 0°C; -67 to 122°F) (Enabled only when the evaporator probe is present) sets the temperature measured by the evaporator probe <b>dPb</b> , which causes the end of defrost.
idf	<b>Interval between defrosts:</b> (0 to 120 hours) Determines the time interval between the beginning of two defrost cycles.
idE	<b>Time to next defrost log into not volatile memory</b> <b>No:</b> Time to next defrost is not logged into no volatile memory, this means controller will use the idF interval after a power off. E.I. idF = 8: controller performs a defrost every 8 hours. If controller is switched off, independently from when the last defrost occurred, at power on it will trigger the first defrost after 8 hours. <b>Yes:</b> Time to next defrost is logged into no volatile memory, this means the controller will use it after a power off. E.I. idF = 8: controller performs a defrost every 8 hours. If controller is switched off 6 hours after last defrost, at power on it will do the first defrost after 2 hours (6+2 = 8). This is useful in places subjected to frequent power outages.

Table 17-1 - Parameter List

Parameter	Description
ndt	<b>Minimum duration of defrost:</b> (0 to MdF minute) Sets the minimum defrost duration, independently from the temperature reached by the end defrost probes.
MdF	<b>Maximum duration of defrost:</b> (ndt to 255 minutes) When dPA and dPb are not present, it sets the defrost duration; otherwise, it sets the maximum duration for defrost.
dSd	<b>Start defrost delay:</b> (0 to 255 minutes) This is useful when different defrost start times are necessary to avoid overloading the plant.
dFd	<b>Display during defrost:</b> rt = real temperature; it = temperature reading at the defrost start; Set = setpoint; dEF = "dEF" label.
dAd	<b>Defrost display time out:</b> (0 to 255 minutes) Sets the maximum time between the end of defrost and the restarting of the real room temperature display.
Fdt	<b>Drain down time:</b> (0 to 255 minutes) Time interval between reaching defrost termination temperature and the restoring of the control's normal operation. This time allows the evaporator to eliminate water drops that might have formed due to defrost.
dPo	<b>First defrost after start-up:</b> Y = Immediately; N = after the IdF time
dAF	<b>Defrost delay after continuous cycle:</b> (0 to 23.5 hours) Time interval between the end of the fast freezing cycle and the following defrost related to it.
<b>PUMP DOWN</b>	
Pdt	<b>Pump down type (nu, FAn, F-C)</b> nu: Pump down disabled FAn: Pump down enabled. Fan is activated for pump down duration, compressor relay/solenoid valve is switched off with CrE=n/Y or activated with CrE=EUP or EU5. F-C: Pump down enabled. Fan and compressor relay are activated for pump down duration. See above for solenoid valve behavior.
Pdn	<b>Pump down duration</b> (0 to 255 minutes)
<b>ON DEMAND DEFROST</b>	
Ctd	<b>Differential for defrost start</b> (0.1°C to 25.5°C, 1°F to 45°F)
nbd	<b>Minimum Compressor run time before defrost</b> 0.0 to 24h00 minutes)
Mdb	<b>Maximum Compressor run time before defrost</b> (0.0 to 24h00 minutes)
nct	<b>Minimum coil temperature to trigger a defrost</b> (-55.0°C to 150.0°C; 67°F to 302°F]
<b>FAN</b>	
FAP	<b>Fan probe A:</b> (nP; P1; P2, P3, P4, P5) First probe used for fan. If FPA = nP the regulation is performed with real value of FPB.
FnC	<b>Fan operating mode:</b> C-n = running with the solenoid valve, OFF during the defrost; C-y = running with the solenoid valve, ON during the defrost; O-n = continuous mode, OFF during the defrost; O-y = continuous mode, ON during the defrost.
Fnd	<b>Fan delay after defrost:</b> (0 to 255 minutes) The time interval between the defrost end and evaporator fans start.
Fct	<b>Temperature differential avoiding short cycles of fans</b> (0.0°C to 50.0°C; 0°F to 90°F) If the difference of temperature between the evaporator and the room probes is more than the value of the Fct parameter, the fans are switched on.
FSt	<b>Fan stop temperature:</b> (-50 to 110°C; -58 to 230°F) Setting of temperature, detected by evaporator probe, above which the fan is always OFF.
FHy	<b>Differential to restart fan:</b> (0.1°C to 25.5°C) (1°F to 45°F) When stopped, fan restarts when fan probe reaches FSt-FHy temperature.
tFE	<b>Fan regulation by temperature during defrost</b> (N, Y)
Fod	<b>Fan activation time after defrost:</b> (0 to 255 minutes) It forces fan activation for indicated time.

Table 17-1 - Parameter List

Parameter	Description
Fon	<b>Fan ON time:</b> (0 to 15 minutes) With Fnc = C_n or C_y, (fan activated in parallel with compressor). It sets the evaporator fan ON cycling time when the compressor is off. With Fon = 0 and FoF ≠ 0 the fan are always off, with Fon = 0 and FoF = 0 the fan are always off.
FoF	<b>Fan OFF time:</b> (0 to 15 minutes) With Fnc = C_n or C_y, (fan activated in parallel with compressor). It sets the evaporator fan OFF cycling time when the compressor is OFF. With Fon = 0 and FoF ≠ 0 the fan are always OFF, with Fon = 0 and FoF = 0 the fan are always OFF.
<b>MODULATING OUTPUT - if present</b>	
trA	<b>Kind of regulation with PWM output:</b> (UAL – rEG – AC) It selects the functioning for the PWM output. <b>UAL</b> = the output is at FSA value; <b>rEG</b> = the output is regulated with fan algorithm described in fan section; <b>AC</b> = anti-sweat heaters control (require the XWEB5000 system).
SOA	<b>Fixed value for analog output:</b> (0 to 100%) Value for the output if trA = UAL.
SdP	<b>Default value for Dewpoint:</b> (-55,0 to 50,0°C; -67 to 122°F) Default value of dewpoint used when there is no supervising system (XWEB5000). Used only when trA=AC.
ASr	<b>Dew-point offset (trA = AC) / Differential for modulating fan regulation (trA=rEG):</b> (-25.5°C to 25.5°C) (-45°F to 45°F).
PbA	<b>Differential for anti-sweat heaters:</b> (0.1°C to 25.5°C) (1°F to 45°F)
AMi	<b>Minimum value for analog output:</b> (0 to AMA)
AMA	<b>Maximum value for analog output:</b> (Ami to 100)
AMt	<b>Anti-sweat heaters cycle period (trA = AC)/ Time with fan at maximum speed (trA = rEG):</b> (0 to 255 seconds) when the fan starts, during this time the fan is at maximum speed.
<b>ALARMS</b>	
rAL	<b>Probe for temperature alarm:</b> (nP - P1 - P2 - P3 - P4 - P5 – tEr) It selects the probe used to signal alarm temperature.
ALC	<b>Temperature alarm configuration:</b> rE = High and Low alarms related to Setpoint; Ab = High and low alarms related to the absolute temperature.
ALU	<b>High temperature alarm setting:</b> (ALC= rE, 0 to 50°C or 90°F / ALC= Ab, ALL to 150°C or 302°F) when this temperature is reached and after the ALd delay time the HA alarm is enabled.
ALL	<b>Low temperature alarm setting:</b> (ALC = rE, 0 to 50 °C or 90°F / ALC = Ab, - 55°C or - 67°F to ALU) when this temperature is reached and after the ALd delay time, the LA alarm is enabled.
AHy	<b>Differential for temperature alarm:</b> (0.1°C to 25.5°C / 1°F to 45°F) Intervention differential for recovery of temperature alarm.
ALd	<b>Temperature alarm delay: (0 to 255 minutes) time interval between the detection of an alarm condition and the corresponding alarm signaling.</b>
rA2	<b>Probe for second temperature alarm:</b> (nP - P1 - P2 - P3 - P4 - P5 – tEr) It selects the probe used to signal alarm temperature.
A2U	<b>Second high temperature alarm setting:</b> (A2L to 150°C or 302°F) When this temperature is reached and after the A2d delay time the HA2 alarm is signaled.
A2L	<b>Second Low temperature alarm setting:</b> (- 55°C or - 67°F to A2U) When this temperature is reached and after the A2d delay time, the LA2 alarm is signaled.
A2H	<b>Differential for second temperature alarm:</b> (0.1°C to 25.5°C / 1°F to 45°F) Intervention differential for recovery of second temperature alarm.
Ad2	<b>Second temperature alarm delay:</b> (0 to 255 minutes) time interval between the detection of second temperature alarm condition and the corresponding alarm signaling.
dAO	<b>Delay of temperature alarm at start-up:</b> (0 minute to 23 hours, 50 minutes) Time interval between the detection of the temperature alarm condition after the instrument power on and the alarm signaling.
EdA	<b>Alarm delay at the end of defrost:</b> (0 to 255 minutes) Time interval between the detection of the temperature alarm condition at the end of defrost and the alarm signaling.

Table 17-1 - Parameter List

Parameter	Description
dot	Temperature alarm exclusion after door open: (0 to 255 minutes)
Sti	Stop regulation interval (Only XM678D): (0.0 to 24.0 hours: tens of minutes) After regulating continuously for Sti time, the valve closes for Std time in order to prevent ice creation.
Std	Stop duration (Only XM678D): (0 to 60 minutes) It defines stop regulation time after Sti.
tbA	Disabling alarm relay by pressing a key: (N; Y)
<b>OPTIONAL OUTPUT (only for XM678D)</b>	
oA5	Relay at term. 1-2-3 configuration: (nP – CPr -CP2- -dEF-Fan-ALr-LiG-AUS-Htr-OnF - AC): nP = not used; CPr= relay works as a compressor or solenoid valve relay; CP2= relay works as second dEF= relay works as defrost relay; Fan= relay works as a Fan relay; ALr= activation with alarm conditions; LiG= light activation; AUS= auxiliary relay, it can be switched ON/OFF also by key; Htr = deadband regulation (not compatible with CrE=y); OnF = ON/OFF functioning, AC = anti sweat heaters.
oA6	Relay at term. 17-18 configuration: nP – CPr -CP2- -dEF-Fan-ALr-LiG-AUS-Htr-OnF - AC): nP = not used; CPr= relay works as a compressor or solenoid valve relay; CP2= relay works as second dEF= relay works as defrost relay; Fan= relay works as a Fan relay; ALr= activation with alarm conditions; LiG= light activation; AUS= auxiliary relay, it can be switched ON/OFF also by key; Htr = deadband regulation (not compatible with CrE = y); OnF= ON/OFF functioning, AC = anti sweat heaters.
CoM	Type of functioning modulating output: <ul style="list-style-type: none"> <li>• For models with PWM / O.C. output to PM5= PWM 50Hz; PM6= PWM 60Hz; OA7= not set it;</li> <li>• For models with 4 to 20mA / 0 to 10V output to Cur= 4 to 20mA current output; tEn= 0 to 10V voltage output.</li> </ul>
AOP	Alarm relay polarity: cL= normally closed; oP = normally opened.
iAU	Auxiliary output is unrelated to ON/OFF device status: n= if the instrument is switched off also the auxiliary output is switched off; Y= the auxiliary output state is unrelated to the ON/OFF device status.
<b>DIGITAL INPUTS</b>	
i1P	Digital input 1 polarity: (cL – oP) CL: the digital input is activated by closing the contact; OP: the digital input is activated by opening the contact.
i1F	Digital input 1 function: (nu - EAL – bAL – PAL – dor – dEF – AUS – LiG – OnF – Htr – FHU – ES – HdY) nu = not used; EAL= external alarm; bAL= serious external alarm; PAL= pressure switch activation; dor= door open; dEF= defrost activation; AUS= auxiliary activation; LiG= light activation; OnF= switch on/off the instrument; FHU= not used; ES= activate energy saving; nt = second map enabling; cLn = clean function dEn = defrost off, CP1 = compressor 1 safety, CP2 = compressor 2 safety.
d1d	Time interval/delay for digital input alarm: (0 to 255 minutes) Time interval to calculate the number of the pressure switch activation when i1F=PAL. If i1F=EAL or bAL (external alarms), “d1d” parameter defines the time delay between the detection and the successive signaling of the alarm. If i1F=dor this is the delay to activate door open alarm.
i2P	Digital input 2 polarity: (cL – oP) CL: the digital input is activated by closing the contact; OP: the digital input is activated by opening the contact.
i2F	Digital input 2 function: (nu - EAL – bAL – PAL – dor – dEF – AUS – LiG – OnF – Htr – FHU – ES – HdY) nu = not used; EAL= external alarm; bAL= serious external alarm; PAL= pressure switch activation; dor= door open; dEF= defrost activation; AUS= auxiliary activation; LiG= light activation; OnF= switch on/off the instrument; FHU= not used; ES= activate energy saving; nt = second map enabling; cLn = clean function dEn = defrost off, CP1 = compressor 1 safety, CP2 = compressor 2 safety.
d2d	Time interval/delay for digital input alarm: (0 to 255 minutes) Time interval to calculate the number of the pressure switch activation when i2F=PAL. If i2F=EAL or bAL (external alarms), “d2d” parameter defines the time delay between the detection and the successive signaling of the alarm. If i2F=dor this is the delay to activate door open alarm.
i3P	Digital input 3 polarity: (cL – oP) CL: the digital input is activated by closing the contact; OP: the digital input is activated by opening the contact.

Table 17-1 - Parameter List

Parameter	Description
i3F	<b>Digital input 3 function:</b> (nu - EAL - bAL - PAL - dor - dEF - AUS - LiG - OnF - Htr - FHU - ES - Hdy) nu = not used; <b>EAL</b> = external alarm; <b>bAL</b> = serious external alarm; <b>PAL</b> = pressure switch activation; <b>dor</b> = door open; <b>dEF</b> = defrost activation; <b>AUS</b> = auxiliary activation; <b>LiG</b> = light activation; <b>OnF</b> = switch on/off the instrument; <b>FHU</b> = not used; <b>ES</b> = activate energy saving; <b>nt</b> = second map enabling; <b>cLn</b> = clean function <b>dEn</b> = defrost off, <b>CP1</b> = compressor 1 safety, <b>CP2</b> = compressor 2 safety.
d3d	<b>Time interval/delay for digital input alarm:</b> (0 to 255 minutes) Time interval to calculate the number of the pressure switch activation when i3F= <b>PAL</b> . If i3F= <b>EAL</b> or <b>bAL</b> (external alarms), “ <b>d3d</b> ” parameter defines the time delay between the detection and the successive signaling of the alarm. If i3F= <b>dor</b> this is the delay to activate door open alarm.
nPS	<b>Pressure switch number:</b> (0 to 15) Number of activation of the pressure switch, during the “ <b>d#d</b> ” interval, before signaling the alarm event (I2F= PAL). <b>If the nPS activation in the did time is reached, switch off and on the instrument to restart normal regulation.</b>
odc	<b>Compressor and fan status when open door:</b> <b>no</b> = normal; <b>Fan</b> = Fan OFF; <b>CPr</b> = Compressor OFF; <b>F_C</b> = Compressor and fan OFF.
rrd	<b>Outputs restart after doA alarm:</b> <b>No</b> = outputs not affected by the doA alarm; <b>Yes</b> = outputs restart with the doA alarm.
<b>RTC SUBMENU (if present)</b>	
CbP	<b>Clock Presence</b> (N to Y): it permits to disable or enable the clock.
Hur	<b>Current hour</b> (0 to 23 hours)
Min	<b>Current minute</b> (0 to 59 minutes)
dAY	<b>Current day</b> (Sun to Sat)
Hd1	<b>First weekly holiday</b> (Sun to nu) Set the first day of the week that follows the holiday times.
Hd2	<b>Second weekly holiday</b> (Sun to nu) Set the second day of the week that follows the holiday times.
Hd3	<b>Third weekly holiday</b> (Sun to nu) Set the third day of the week that follows the holiday times.
ILE	<b>Energy Saving cycle start during workdays:</b> (0 to 23 hours, 50 minutes) During the Energy Saving cycle the setpoint is increased by the value in HES so that the operation setpoint is SET + HES.
dLE	<b>Energy Saving cycle length during workdays:</b> (0 to 24 hours, 00 minutes) Sets the duration of the Energy Saving cycle on workdays.
ISE	<b>Energy Saving cycle start on holidays.</b> (0 to 23 hours, 50 minutes)
dSE	<b>Energy Saving cycle length on holidays</b> (0 to 24 hours, 00 minute)
HES	<b>Temperature increase during the Energy Saving cycle</b> (-30 to 30°C / -54 to 54°F) Sets the increasing value of the setpoint during the Energy Saving cycle.
Ld1 to Ld6	<b>Workday defrost start</b> (0 to 23 hours, 50 minutes) These parameters set the beginning of the 6 programmable defrost cycles during workdays. Ex. When <b>Ld2</b> = 12.4 the second defrost starts at 12.40 during workdays.
Sd1 to Sd6	<b>Holiday defrost start</b> (0 to 23 hours 50 minutes) These parameters set the beginning of the 6 programmable defrost cycles on holidays. Ex. When <b>Sd2</b> = 3.4 the second defrost starts at 3.40 on holidays.
<b>ENERGY SAVING</b>	
HES	<b>Temperature increase during the Energy Saving cycle:</b> (-30 to 30°C / -54 to 54°F) Sets the increasing value of the setpoint during the Energy Saving cycle.
PEL	<b>Energy saving activation when light is switched off:</b> (N to Y) N= function disabled; Y= energy saving is activated when the light is switched off and vice versa.

Table 17-1 - Parameter List

Parameter	Description
<b>LAN MANAGEMENT</b>	
<b>LMd</b>	<b>Defrost synchronization:</b> <b>Y</b> = the section send a command to start defrost to other controllers, <b>N</b> = the section do not send a global defrost command.
<b>dEM</b>	<b>Type of end defrost:</b> <b>N</b> = the of the LAN defrost are independent; <b>Y</b> = the end of the defrost are synchronization.
<b>LSP</b>	<b>L.A.N. setpoint synchronization:</b> <b>Y</b> = the section setpoint, when modified, is updated to the same value on all the other sections; <b>N</b> = the setpoint value is modified only in the local section.
<b>LdS</b>	<b>L.A.N. display synchronization:</b> <b>Y</b> = the value displayed by the section is sent to all the other sections; <b>N</b> = the setpoint value is modified only in the local section.
<b>LOF</b>	<b>L.A.N. On/Off synchronization</b> this parameter states if the On/Off command of the section will act on all the other ones too: <b>Y</b> = the On/Off command is sent to all the other sections; <b>N</b> = the On/Off command acts only in the local section.
<b>LLi</b>	<b>L.A.N. light synchronization</b> this parameter states if the light command of the section will act on all the other ones too: <b>Y</b> = the light command is sent to all the other sections; <b>N</b> = the light command acts only in the local section.
<b>LAU</b>	<b>L.A.N. AUX output synchronization</b> this parameter states if the AUX command of the section will act on all the other ones too: <b>Y</b> = the light command is sent to all the other sections; <b>N</b> = the light command acts only in the local section.
<b>LES</b>	<b>L.A.N. energy saving synchronization</b> this parameter states if the energy saving command of the section will act on all the other ones too: <b>Y</b> = the Energy Saving command is sent to all the other sections; <b>N</b> = the Energy Saving command acts only in the local section.
<b>LSD</b>	<b>Remote probe display:</b> this parameter states if the section has to display the local probe value or the value coming from another section: <b>Y</b> = the displayed value is the one coming from another section (That has parameter LdS = y); <b>N</b> = the displayed value is the local probe one.
<b>LPP</b>	<b>Remote pressure probe:</b> <b>N</b> = the value of pressure probe is read from local probe; <b>Y</b> = the value of pressure probe is sent via LAN.
<b>LCP</b>	<b>P4 probe sent via LAN</b> (N, Y)
<b>StM</b>	<b>Solenoid activation via LAN:</b> <b>N</b> = not used; <b>Y</b> = a generic cooling requests from LAN activate the solenoid valve connected to compressor relay.
<b>ACE</b>	<b>Cold Calling in LAN always enabled even if the compressor block:</b> (N, Y)
<b>PROBE CONFIGURATION</b>	
<b>P1C</b>	<b>Probe 1 configuration:</b> (nP – Ptc – ntc – PtM) <b>nP</b> = not present; <b>PtC</b> = Ptc; <b>ntc</b> = NTC; <b>PtM</b> = Pt1000
<b>OF1</b>	<b>Probe 1 calibration:</b> (-12.0 to 12.0°C/ -21 to 21°F) allows to adjust possible offset of the thermostat probe.
<b>P2C</b>	<b>Probe 2 configuration:</b> (nP – Ptc – ntc – PtM) <b>nP</b> = not present; <b>PtC</b> = Ptc; <b>ntc</b> = NTC; <b>PtM</b> = Pt1000.
<b>OF2</b>	<b>Probe 2 calibration:</b> (-12.0 to 12.0°C/ -21 to 21°F) allows to adjust possible offsets of the evaporator probe.
<b>P3C</b>	<b>Probe 3 configuration:</b> (nP – Ptc – ntc – PtM) <b>nP</b> = not present; <b>PtC</b> = Ptc; <b>ntc</b> = NTC; <b>PtM</b> = Pt1000.
<b>OF3</b>	<b>Probe 3 calibration:</b> (-12.0 to 12.0°C/ -21 to 21°F) Allows to adjust possible offset of the probe 3.
<b>P4C</b>	<b>Probe 4 configuration:</b> (nP – Ptc – ntc – PtM) <b>nP</b> = not present; <b>PtC</b> = Ptc; <b>ntc</b> = NTC; <b>PtM</b> = Pt1000.
<b>OF4</b>	<b>Probe 4 calibration:</b> (-12.0 to 12.0°C/ -21 to 21°F) Allows to adjust possible offset of the probe 4.
<b>P5C</b>	<b>Probe 5 configuration:</b> (nP – Ptc – ntc – PtM – 420 – 5Vr) <b>nP</b> = not present; <b>PtM</b> = Pt1000; <b>420</b> = 4 to 20mA; <b>5Vr</b> = 0 to 5V ratio-metric; <b>(Only XM678D)</b>
<b>OF5</b>	<b>Probe 5 calibration:</b> (-12.0 to 12.0°C/ -21 to 21°F) Allows to adjust possible offset of the probe 5. <b>(Only XM678D)</b>
<b>P6C</b>	<b>Probe 6 configuration:</b> (nP – Ptc – ntc – PtM) <b>nP</b> = not present; <b>PtC</b> = Ptc; <b>ntc</b> = NTC; <b>PtM</b> = Pt1000; <b>(Only XM678D)</b>

Table 17-1 - Parameter List

Parameter	Description
OF6	<b>Probe 6 calibration:</b> (-12.0 to 12.0°C / -21 to 21°F) Allows to adjust possible offset of the probe 6. <b>(Only XM678D)</b>
PA4	<b>Probe value at 4mA or At 0V:</b> (-1.0 to P20 bar / -14 to PSI / -10 to P20 kPA *10) Pressure value measured by probe at 4mA or at 0V (related to PrM parameter) <b>Referred to Pb5.</b>
P20	<b>Probe value 20mA or At 5V:</b> (PA4 to 50.0 bar / 725 psi / 500 kPA *10) Pressure value measured by probe at 20mA or at 5V (related to PrM parameter) <b>Referred to Pb5.</b>
<b>SERVICE – OTHERS</b>	
LCL	<b>Light on during cleaning mode (N, Y)</b>
FCL	<b>Fan on during cleaning mode (N, Y)</b>
FCL	Map used during standard operation (1°M, 2°M, 3°M, 4°M) It sets the map used by the controller among the four possible maps.
MP1	<b>Alternate Map enabled by digital input or MODBUS command (1°M, 2°M, 3°M, 4°M)</b> It sets the alternate map enabled by digital input or MODBUS command among the four possible maps.
CLt	<b>Cooling time percentage:</b> it shows the effective cooling time calculated by XM600 during regulation.
tMd	<b>Time to next defrost:</b> it shows time before the next defrost if interval defrost is selected.
LSn	<b>L.A.N. section number (1 to 8)</b> Shows the number of sections available in the L.A.N.
Lan	<b>L.A.N. serial address (1 to LSn)</b> Identifies the instrument address inside local network of multiplexed cabinet controller.
Adr	<b>RS485 serial address (1 to 247):</b> Identifies the instrument address when connected to a MODBUS compatible monitoring system.
br	<b>It sets the baud rate among:</b> (96 = 9.6 bit/s; 192 = 19.2 bit/s)
EMU	<b>Previous versions emulation (2V8, 3V8, 4V2)</b> It allows the controller to be used in a LAN of controllers with previous versions: <b>2V8</b> = It emulates version 2.8 <b>3V8</b> = It emulates version 3.8 <b>4V2</b> = It emulates version 4.2
rEL	<b>Release software:</b> (read only) Software version of the microprocessor.
SrL	<b>Software sub-release:</b> (read only) For internal use
Ptb	<b>Parameter table:</b> (read only) It shows the original code of the Emerson parameter map.
Pr2	<b>Access to the protected parameter list</b> (read only).

Table 17-1 - Parameter List

## 18 Digital Inputs

The XM600 series can support up to 3 free of voltage contact configurable digital inputs (depending on the models). They are configurable via i#F parameter

### 18.1. Generic Alarm (EAL)

As soon as the digital input 1, 2, or 3 is activated the unit will wait for “**d1d**” or “**d2d**” or “**d3d**” time delay before signaling the “**EAL**” alarm message. The outputs status do not change. The alarm stops just after the digital input is de-activated.

### 18.2. Serious Alarm Mode (BAL)

When the digital input is activated, the unit will wait for “**d1d**” or “**d2d**” or “**d3d**” delay before signaling the “**BAL**” alarm message. The relay outputs are switched OFF. The alarm will stop as soon as the digital input is de-activated.

### 18.3. Pressure Switch (PAL)

If during the interval time set by “d1d” or “d2d” or “d3d” parameter, the pressure switch has reached the number of activation of the “nPS” parameter, the “CA” pressure alarm message will be displayed. The compressor and the regulation are stopped. When the digital input is ON the compressor is always OFF. **If the nPS activation in the d#d time is reached, switch off and on the instrument to restart normal regulation.**

### 18.4. Door Switch Input (dor)

It signals the door status and the corresponding relay output status through the “odc” parameter: **no** = normal (any change); **Fan** = Fan OFF; **CPr** = Compressor OFF; **F\_C** = Compressor and fan OFF. Since the door is opened, after the delay time set through parameter “d#d”, the door alarm is enabled, the display shows the message “dA” and **the regulation restarts after rrd time.** The alarm stops as soon as the external digital input is disabled again. With the door open, the high and low temperature alarms are disabled.

### 18.5. Start Defrost (DEF)

It executes a defrost if there are the right conditions. After the defrost is finished, the normal regulation will restart only if the digital input is disabled otherwise the instrument will wait until the “Mdf” safety time is expired.

### 18.6. Relay Aux Actuation (AUS)

This function allows the auxiliary relay to turn ON and OFF by using the digital input as external switch.

### 18.7. Relay Light Actuation (LIG)

This function allows the light relay to turn ON and OFF by using the digital input as external switch.

### 18.8. Remote ON/OFF (ONF)

This function allows the instrument to be switched ON and OFF.

### 18.9. FHU – Not Used

This function allows the kind of regulation to be changed from cooling to heating and vice versa.

### 18.10. Energy Saving Input (ES)

The Energy Saving function allows the setpoint value as the result of the SET+ HES (parameter) sum to be changed. This function is enabled until the digital input is activated.

### 18.11. Cleaning Function Activation (CLN)

In this configuration, the digital input activates the CLEANING function. It can be activated only if the device is ON.

This function has the following characteristics:

- The display visualizes the “CLn” label.
- The light status depends on the LCL parameter (no/yes); however, the light can be modified both via button and MODBUS command.
- The fans status depends on the FCL parameter (no/yes), furthermore they are not thermo-regulated (par.FST).

The “CLEANING MODE” MODBUS command has higher priority compared to the digital input.

### 18.12. Defrost End (DEN)

The digital input ends the defrost cycle in progress. The drip time will follow the defrost end. A further defrost request with the digital input active will not be managed.

### 18.13. Digital Inputs Polarity

The digital inputs polarity depends on “I#P” parameters: **CL**: the digital input is activated by closing the contact; **OP**: the digital input is activated by opening the contact.



# 19 Use of the Programming Hot Key



XM controllers can download or upload the parameter list from its own internal memory to the Hot Key and vice-versa through a TTL connector.

Figure 19-1 - Hot Key

## 19.1. Download (From the Hotkey to the Device)

1. Turn OFF the controller by pressing the on/off button  for five (5) seconds. **OFF** will display. Insert the Hot Key into the 5-pin connector labeled **HOT-KEY**, and then turn the controller back ON by pressing the on/off button again for five (5) seconds. The normal temperature value will display to indicate the controller is ON.
2. The parameter list of the Hot Key is downloaded into the controller memory automatically and **doL** will display. After 10 seconds, the controller will start working with the new parameters.
3. **End** will display at the end of the data transfer phase if the controller is programmed correctly. **Err** will display if there is an error or failure in programming.
  - **End** = Correct programming. This means the controller will start regularly with the new programming.
  - **Err** = Failed programming. In this case, turn the controller OFF and then ON if you want to restart the download again or remove the Hot Key to abort the operation.
4. Remove the Hot-Key.

**NOTE:** The procedure may fail if the firmware version and the controller models are different.

## 19.2. Upload (From the Device to the Hotkey)

1. When the XM controller is ON, insert the Hot Key into the 5-pin connector labeled **HOT-KEY**.
2. Press and release the up arrow button.
3. The upload will begin, and **UPL** will blink on the display. **End** will display at the end of the data transfer phase if a successful upload has occurred. **Err** will display if there is an error or failure in programming.
  - **End** = Correct programming.
  - **Err** = Failed programming. In this case, press the **SET** key if you want to restart the programming again or remove the unprogrammed Hot-Key.
4. Remove the Hot Key.

**NOTE:** The upload procedure will overwrite everything previously uploaded from the last Hot Key upload.

# 20 Technical Data

CX660 KEYBOARD	
Housing	Self-extinguishing ABS
Dimensions	<b>Case:</b> CX660 fascia <b>Front:</b> 35 mm x 77 mm <b>Depth:</b> 18 mm
	<b>Panel Mount:</b> 29 mm x 71 mm panel cut-out
Protection	IP20
	<b>Frontal:</b> IP65
Power Supply	From XM600K power module
Display	Three (3) digits, red LED, 14.2 mm high
Optional Output	Buzzer
POWER MODULES	
Case	8 DIN
Connections	Screw terminal block $\leq 1.6 \text{ mm}^2$ heat-resistant wiring and 5.0 mm Faston or screw terminals
Power Supply	Depending on the model 12Vac – 24Vac - 110Vac to 10% - 230Vac to 10% or 90 to 230Vac with switching power supply.
Power Absorption	9VA max
Inputs	Up to 6 NTC/PTC/Pt1000 probes
Digital Inputs	Three (3) voltage-free
Relay Outputs ( <u>Total current on loads MAX 16A</u> )	<b>Solenoid Valve:</b> relay SPST 5(3)A, 250Vac <b>Defrost:</b> relay SPST 16A, 250Vac <b>Fan:</b> relay SPST 8A, 250Vac <b>Light:</b> relay SPST 16A, 250Vac <b>Alarm:</b> SPDT relay 8A, 250Vac <b>Aux:</b> SPST relay 8A, 250Vac
Valve Output	A.c. output from 10W up to 30W
Optional Output (AnOUT) Depending on the model	<b>PWM/ Open Collector outputs:</b> PWM or 12VDC max 40mA
	<b>Analog Output:</b> 4 to 20mA or 0 to 10V
Serial Output	RS485 with MODBUS-RTU and LAN
Data Storing	On the volatile memory (EEPROM)
Kind of Action	1B
Pollution Degree	2
Software Class	A
Operating Temperature	32 to 140°F (0 to 60°C)
Storage Temperature	-13 to 140°F (-25°C to 60°C)
Relative Humidity	20 to 85% (no condensing)
Measuring and Regulation Range	<b>NTC probe:</b> -58 to 230°F (-40 to 110°C)
	<b>PTC probe:</b> -67 to 302°F (-50 to 150°C)
	<b>Pt1000 probe:</b> -148 to 212°F (-100 to 100°C)
Resolution	1°C or 1°F or 0.1°C (selectable)

Table 20-1- XM678D Technical Specifications

# 21 Default Setting Values

Label	M1	M2	M3	M4	Menu	Parameters Description
rtc	---				Pr1	Access by RTC submenu
EEU	---				Pr1	Access by RTC submenu
SEt	2.0	2.0	2.0	2.0	---	Setpoint
SEC	LOC				---	LAN mode selection: Local or Global
Hy	2.0	2.0	2.0	2.0	Pr1	Differential
int	150	150	150	150	Pr2	Integral time for room temperature regulation
CrE	n				Pr2	Continuous regulation activation
LS	-30	-30	-30	-30	Pr2	Minimum setpoint
US	10	10	10	10	Pr2	Maximum setpoint
odS	1				Pr2	Outputs activation delay at start up
AC	0				Pr2	Anti-short cycle delay
CCt	0.0				Pr2	Continuous cycle duration
CCS	2.0				Pr2	Continuous cycle setpoint
Con	5				Pr2	Compressor ON time with faulty probe
CoF	10				Pr2	Compressor OFF time with faulty probe
CF	°C				Pr2	Measurement unit: Celsius, Fahrenheit
PrU	rE				Pr2	Pressure Mode
PMU	bAr				Pr2	Pressure measurement unit
PMD	PrE				Pr2	Pressure displaying mode: temperature or pressure
rES	dE				Pr2	Resolution (only C): decimal, integer
Lod	P1				Pr2	Local display: default display
rEd	P1				Pr1	Remote display: default display
dLy	0				Pr2	Display delay
rPA	P1				Pr2	Regulation probe A
rPb	nP				Pr2	Regulation probe B
rP3	nP				Pr2	Regulation probe 3
rP4	nP				Pr2	Regulation probe 4
rP5	nP				Pr2	Regulation probe 5
rPd	rPA				Pr2	Temperature Regulation Strategy
rPE	100				Pr2	Virtual probe percentage (rPd = rAb)
Fty	448				Pr2	Refrigerant gas type
ATU	n	y	n	y	Pr2	Regulator auto tuning
AMS	n	n	n	n	Pr2	Min Superheat search
SSH	6.0	6.0	6.0	6.0	Pr2	Superheat setpoint
SHy	0.0	0	0	0	Pr2	Differential for low superheat function
Pb	8	8	8	8	Pr2	Regulation proportional band
PbH	0.2	0.2	0.2	0.2	Pr2	Dead band for superheat regulation
rS	0	0.0	0.0	0.0	Pr2	Band Offset

Table 21-1 - Default Setting Values

Label	M1	M2	M3	M4	Menu	Parameters Description
<b>inC</b>	220	220	220	220	Pr2	PID integration time
<b>dFC</b>	1	1	1	1	Pr2	PID derivation constant time
<b>PEd</b>	On				Pr2	Delay before stopping regulation with probe error
<b>PEO</b>	50				Pr2	Probe Error opening percentage
<b>SFd</b>	0.3				Pr2	Duration of Soft Start phase
<b>SFP</b>	40.0				Pr2	Open percentage for soft start phase
<b>OHG</b>	45.0	45.0	45.0	45.0	Pr2	Open percentage for inversion defrost
<b>Pdd</b>	0.4				Pr2	Duration for post defrost phase
<b>OPd</b>	50.0				Pr2	Open percentage for post defrost phase
<b>LnF</b>	10.0	10.0	10.0	10.0	Pr2	Minimum open percentage for stepper valve
<b>MnF</b>	100	100	100	100	Pr2	Maximum open percentage for stepper valve
<b>dCL</b>	0				Pr2	Regulation off delay, when the setpoint is reached 2
<b>Fot</b>	nu				Pr2	Enable for forcing open valve to a fixed value
<b>LPL</b>	-0.5				Pr2	Minimum value threshold of pressure for regulation
<b>MOP</b>	4.5	4.5	4.5	4.5	Pr2	Maximum value threshold of suction pressure
<b>dMP</b>	10				Pr2	Delay for high pressure alarm activation (MOP)
<b>LOP</b>	-0.5	-0.5	-0.5	-0.5	Pr2	Minimum value threshold of suction pressure
<b>dLP</b>	10				Pr2	Delay for low pressure alarm activation (LOP)
<b>dML</b>	2.0	2.0	2.0	2.0	Pr2	Opening steps variation during MOP and LOP
<b>AAS</b>	n				Pr2	Low superheat alarm with "XeCO2 function active
<b>HSH</b>	60				Pr2	Threshold for maximum superheat alarm
<b>LSH</b>	2				Pr2	Threshold for minimum superheat alarm
<b>dHS</b>	0.3				Pr2	Delay for high superheat alarm
<b>dLS</b>	0.3				Pr2	Delay for low superheat alarm
<b>LSA</b>	1.0				Pr2	Subtracting percentage with low superheat alarm
<b>FrC</b>	50				Pr2	Additional integration constant for fast recovery
<b>AnP</b>	3	3	3	3	Pr2	Number of average value for converted temperature (pressure)
<b>Ant</b>	1	1	1	1	Pr2	Number of average value for temperature
<b>SLb</b>	1	1	1	1	Pr2	Reaction time (interval for valve PID management)
<b>tEP</b>	nU				Pr2	Predefined valve selection
<b>tEU</b>	bP				Pr2	Kind of valve
<b>bdM</b>	noM				Pr2	Bipolar valve pilot mode: Wave Mode- Normal Mode
<b>HFS</b>	FUL				Pr2	Kind of motor movement
<b>LSt</b>	0				Pr2	Minimum number of steps where the valve can be considered as completely closed
<b>USt</b>	0				Pr2	Maximum number of steps that can be performed
<b>Est</b>	0				Pr2	Extra steps in closing phase
<b>Sr</b>	10				Pr2	Step rate: The speed to change step. A too high value causes a wrong driving
<b>CPP</b>	0				Pr2	Current per phase during bipolar valve driving
<b>CHd</b>	0				Pr2	Current per phase to maintain the actual position (Holding current)

Table 21-1 - Default Setting Values

Label	M1	M2	M3	M4	Menu	Parameters Description
GtC	0				Pr2	Interval between cycles to reset the valve
GtH	10				Pr2	Auto-zero function
dtY	100				Pr2	Pilot duty
dPA	P2				Pr2	Defrost probe A
dPb	nP				Pr2	Defrost probe B
tdF	EL	EL	EL	EL	Pr2	Kind of defrost: air, resistors, inversion
EdF	in				Pr2	Defrost mode: Clock or interval
Srt	150				Pr2	Differential for heater
Hyr	2.0				Pr2	Time out for heater (if temp > Srt)
tod	255				Pr2	Defrost with two probes
d2P	n	n	n	n	Pr2	Defrost with two probes
dtE	8.0	8.0	8.0	8.0	Pr2	First defrost termination temperature
dtS	8.0	8.0	8.0	8.0	Pr2	Second defrost termination temperature
idF	6	6	6	6	Pr2	Interval between defrosts
idE	y				Pr2	Storage in EEPROM defrost interval
ndt	3	3	3	3	Pr2	Minimum Defrost Time
MdF	30	30	30	30	Pr2	Maximum defrost duration
dSd	0				Pr2	Delay for defrost on call
dFd	it				Pr2	Visualization during defrost
dAd	30				Pr2	Visualization delay for temperature after defrost
Fdt	0	0	2	2	Pr2	Dripping time
dPo	n				Pr2	Defrost at power ON
dAF	0				Pr2	Delay defrost after freezing
Pdt	F-C				Pr2	Pump down type
Pdn	0				Pr2	Pump down duration
Ctd	6	6	6	6	Pr2	Differential for defrost start
nbd	4.0	4.0	4.0	4.0	Pr2	Minimum Compressor run time before defrost
Mdb	16.0	16.0	16.0	16.0	Pr2	Maximum Compressor run time before defrost
nct	-30	-30	-30	-30	Pr2	Minimum coil temperature to trigger a defrost
FAP	P2				Pr2	Fan probe A
FnC	O-y	o-y	o-n	o-n	Pr2	Fan operating mode
Fnd	0	0	5	5	Pr2	Fan delay after defrost
FCt	10				Pr2	Temperature differential to avoid short cycles of fans
FSt	15.0	15.0	2.0	2.0	Pr2	Fan stop temperature
FHy	1.0				Pr2	Fan stop hysteresis
tFE	n				Pr2	Fan regulation by temperature in defrost
Fod	0				Pr2	Fan activation time after defrost (without compressor)
Fon	0				Pr2	Fan ON time
FoF	0				Pr2	Fan OFF time
trA	UAL				Pr2	Kind of regulation with PWM output

Table 21-1 - Default Setting Values

Label	M1	M2	M3	M4	Menu	Parameters Description
SOA	0				Pr2	Fixed speed for fan
SdP	30.0				Pr2	Default Dewpoint value
ASr	1.0				Pr2	Differential for fan / offset for anti sweat heater
PbA	5.0				Pr2	Proportional band for modulating output
AMi	0				Pr2	Minimum output for modulating output
AMA	100				Pr2	Maximum output for modulating output
AMt	3				Pr2	1:Time with fan at maximum speed 2:The control period for the anti-sweat control
rAL	tEr				Pr2	Probe for temperature alarm
ALC	Ab				Pr2	Temperature alarm configuration: relative / absolute
ALU	10	10	10	10	Pr2	High temperature alarm setting
ALL	-30	-30	-30	-30	Pr2	Low temperature alarm setting
AHy	1.0				Pr2	Differential for temperature alarm
ALd	15	15	15	15	Pr2	Temperature alarm delay
rA2	nP				Pr2	Probe for temperature alarm 2
A2U	150	150	150	150	Pr2	High temperature alarm 2 setting
A2L	-40	-40	-40	-40	Pr2	Low temperature alarm 2 setting
A2H	2				Pr2	Differential for temperature alarm 2
A2d	15	15	15	15	Pr2	Temperature alarm delay 2
dAO	1.0	1.0	1.0	1.0	Pr2	Delay of temperature alarm at start-up
EdA	60				Pr2	Alarm delay at the end of defrost
dot	30				Pr2	Temperature alarm exclusion after door open
Sti	nu	nu	nu	nu	Pr2	Time for compressor ON before regulation break
Std	10	3	3	3	Pr2	Time for compressor OFF for regulation break
tbA	n				Pr2	Silencing alarm relay with buzzer
oA5	ALr				Pr2	Relay 5 configuration
oA6	AUS				Pr2	Relay 6 configuration
CoM	420				Pr2	Modulating output configuration
AOP	CL				Pr2	Alarm relay polarity
iAU	n				Pr2	Auxiliary output independent from ON/OFF state
i1P	cL				Pr2	Digital input 1 polarity
i1F	dor				Pr2	Digital input 1 configuration
d1d	15				Pr2	Digital input 1 activation delay
i2P	cL				Pr2	Digital input 2 polarity
i2F	LiG				Pr2	Digital input 2 configuration
d2d	5				Pr2	Digital input 2 activation delay
i3P	cL				Pr2	Digital input 3 polarity
i3F	ES				Pr2	Digital input 3 configuration
d3d	0				Pr2	Digital input 3 activation delay
nPS	15				Pr2	Pressure switch number

Table 21-1 - Default Setting Values

Label	M1	M2	M3	M4	Menu	Parameters Description
OdC		F-C			Pr2	Compressor and fan status when open door
rrd		30			Pr2	Outputs restart after door open alarm
CbP		y			Pr2	Clock presence
Hur		---			Pr1	Current hour
Min		---			Pr1	Current minutes
dAY		---			Pr1	Current day
Hd1		nu			Pr1	First weekly day
Hd2		nu			Pr1	Second weekly day
Hd3		nu			Pr1	Third weekly day
ILE		0.0			Pr1	Energy saving cycle start during workdays
dLE		0.0			Pr1	Energy saving cycle length during workdays
ISE		0.0			Pr1	Energy saving cycle start during holidays
dSE		0.0			Pr1	Energy saving cycle length during holidays
HES		0.0			Pr2	Temperature increasing during Energy Saving
Ld1		6.0			Pr1	Workdays First defrost start
Ld2		13.0			Pr1	Workdays Second defrost start (minimum as Ld1)
Ld3		21.0			Pr1	Workdays Third defrost start (minimum as Ld2)
Ld4		nu			Pr2	Workdays Fourth defrost start (minimum as Ld3)
Ld5		nu			Pr2	Workdays Fifth defrost start (minimum as Ld4)
Ld6		nu			Pr2	Workdays Sixth defrost start (minimum as Ld5)
Sd1		6.0			Pr1	Holidays First defrost start
Sd2		13.0			Pr1	Holidays Second defrost start
Sd3		21.0			Pr1	Holidays Third defrost start
Sd4		nu			Pr1	Holidays Fourth defrost start
Sd5		nu			Pr1	Holidays Fifth defrost start
Sd6		nu			Pr1	Holidays Sixth defrost start
HES		0.0			Pr2	Temperature increasing during Energy Saving
PEL		n			Pr2	Energy saving activation when Light switched off
LMd		y			Pr2	Defrost Synchronization
dEM		y			Pr2	Defrost end Synchronization
LSP		n			Pr2	Setpoint Synchronization
LdS		n			Pr2	Display Synchronization (temperature sent via LAN)
LOF		n			Pr2	ON/OFF Synchronization
LLi		y			Pr2	Light Synchronization
LAU		n			Pr2	AUX Synchronization
LES		n			Pr2	Energy Saving Synchronization
LSd		n			Pr2	Remote probe displaying
LPP		n			Pr2	Pressure value sent in LAN
LCP		n			Pr2	P4 probe sent via LAN
StM		n			Pr2	Cooling request from LAN enable compressor relay

Table 21-1 - Default Setting Values

Label	M1	M2	M3	M4	Menu	Parameters Description
ACE		n			Pr2	Cold Calling in LAN always enabled even if the compressor block
P1C		ntc			Pr2	P1 configuration
OF1		0.0			Pr2	P1 calibration
P2C		ntc			Pr2	P2 configuration
OF2		0.0			Pr2	P2 calibration
P3C		nu			Pr2	P3 configuration
OF3		0.0			Pr2	P3 calibration
P4C		nu			Pr2	P4 configuration
OF4		0.0			Pr2	P4 calibration
P5C		420			Pr2	P5 configuration
OF5		0.0			Pr2	P5 calibration
P6C		PtM			Pr2	P6 configuration
OF6		0.0			Pr2	P6 calibration
PA4		0.5			Pr2	Probe value at 4 mA or at 0V (probe P5)
P20		11.0			Pr2	Probe value at 20 mA or at 5V (probe P5)
LCL		y			Pr2	Light on during cleaning mode
FCL		y			Pr2	Fan on during cleaning mode
MAP		1°M			Pr2	Map selection
MP1		1°M			Pr2	Map selection loaded by digital input
Adr		1			Pr1	MODBUS address
br		96			Pr2	Baud Rate selection for MODBUS: 9600 or 19200
EMU		nu			Pr2	Emulation previous version: 2V8, 3V8, 4V2
rEL		5.4			Pr2	Release code firmware (only read)
SrL		-			Pr2	Sub-release firmware (only read)
Ptb		-			Pr2	Map EEPROM ID
Pr2		321			Pr1	Password

Table 21-1 - Default Setting Values

This document may be photocopied for personal use.  
 Visit our website at [www.climate.emerson.com](http://www.climate.emerson.com) for the latest technical documentation and updates.  
 Join Emerson Technical Support on Facebook. <http://on.fb.me/WUQRnt>  
 For Technical Support call 833-409-7505 or email [ColdChain.TechnicalServices@Emerson.com](mailto:ColdChain.TechnicalServices@Emerson.com)

The contents of this publication are presented for informational purposes only and they are not to be construed as warranties or guarantees, express or implied, regarding the products or services described herein or their use or applicability. Emerson reserves the right to modify the designs or specifications of such products at any time without notice. Responsibility for proper selection, use and maintenance of any product remains solely with the purchaser and end-user. ©2022 Emerson is a trademark of Emerson Electric Co.