

50M56X-843

Universal Integrated Single Stage 120V Hot Surface Ignition Control Kit

INSTALLATION INSTRUCTIONS

**FAILURE TO READ AND FOLLOW ALL INSTRUCTIONS CAREFULLY BEFORE
INSTALLING OR OPERATING THIS CONTROL COULD CAUSE PERSONAL
INJURY AND/OR PROPERTY DAMAGE.**

DESCRIPTION

50M56X-843 is an aftermarket universal replacement control kit for single stage furnace applications with PSC or ECMx (constant torque) blower motors. A HotRod™ 120V ignitor is included to replace ignitors in most furnaces as well as upgrade 80V systems to 120V.

With 50M56X-843 no complex adapter harnesses are required, instead all connectors and terminals used in the major OEM brands are included on the control itself. This allows for OEM wiring to be connected directly to the control for a faster and easier installation.

Included in the box:

- 1 – 50M56X-843 Ignition Control
- 1 – HotRod™ Ignitor
- 1 – Installation Instructions
- 4 – 1/2" Sheet Metal Mounting Screws
- 6 – 3/16" QC crimp on terminals
- 6 – 1/4" Female Spade Terminals
- 5 – Mounting Standoffs

**View Installation
Resources**



ELECTRICAL SPECIFICATIONS

Specification	Value	Unit
Input Voltage	18-30	VAC
Input Current	Max 800	mA
Line Frequency	60	Hz
Inducer Relay at 120V	2.8A	FLA
Gas Valve Relay @ 30V	1.5	Amperes
Ignitor Relay @ 120V	1.2	Amperes
PSC Circulator Relay	10	FLA

OPERATING TEMPERATURE RANGE:

-40° to 176°F (-40° to 80°C)

HUMIDITY RANGE:

5 to 95% relative humidity (non-condensing)

GASES APPROVED:

Natural, Manufactured, Mixed, Liquid Petroleum, and LP Gas Air Mixtures

CONTENTS

Description.....	1
Precautions.....	1
Configuration	2
Installation	3
Application & Operation Notes.....	5
Wiring Diagram.....	7
Troubleshooting.....	11

INSTALLER MUST READ

**APPLICATION AND OPERATION NOTES ON
PAGES 5, 6, & 7**

WARNING



Failure to comply with the following warnings could result in personal injury or property damage.

- Installation should be done by a qualified heating and air conditioning contractor or licensed electrician.
- All wiring must conform to local and national electrical codes and ordinances.
- Following installation or replacement, follow manufacturer's recommended installation/service instructions to ensure proper operation.

FIRE HAZARD

- Do not exceed the specified voltage.
- Protect module from direct contact with water (dripping, spraying, rain, etc.).
- If the module has been in direct contact with water, replace the module.
- Label all wires before disconnection when servicing modules. Wiring errors can cause improper and dangerous operation.
- Route and secure wiring away from flame.

SHOCK HAZARD

- Disconnect electric power before servicing.
- Ensure proper earth grounding of appliance.
- Ensure proper connection of line neutral and line hot wires.
- Ensure module has 1/4" clearance between all sides of module and grounded metal.

EXPLOSION HAZARD

- Shut off main gas to appliance until installation is complete.



MOBILE APP CONFIGURATION (PREFERRED)

For fastest setup, use White-Rodgers Connect App:

1. Download from iOS App Store or Google Play Store
2. Open White-Rodgers Connect App
3. Touch "Connect to Control" on the home page
4. Place Device above NFC Logo on Module, wait for check mark
5. Configure all settings in App
6. Touch "Update Control"
7. Place Device above NFC Logo on Module, wait for check mark



- App tutorial available on homepage of White-Rodgers Connect
- NFC available on iOS 13 and greater (iPhone 7 and up) and all Android devices

ON BOARD CONFIGURATION (7-SEGMENT OPTION)

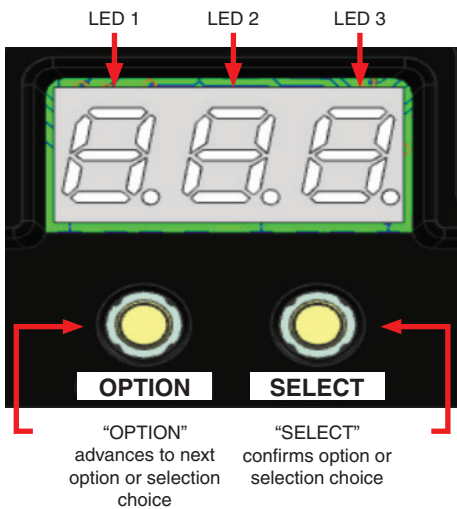

Condition	LED Display	Description
Module Power Up	888	During power up, LEDs remain steady
Auto Configuration	dcF	Automatic Configuration Must Complete before entering standby ~30 sec
Standby	0n	Control ready to configure or respond to calls

Action	Module Status	Button Press
Enter Configuration Menu	In Standby Mode	OPTION
Advance 1 Option Menu Item	In Configuration Menu	OPTION
Enter Selections Menu Level	At Options Menu Level	SELECT
Advance 1 Selection Item	At Selections Menu Level	OPTION
Confirm Selection	On Chosen Selection	SELECT
Exit Configuration Menu	On No. 22 in Configuration Menu	OPTION

Note: See Table 1 on page 3 for Configuration Menu Options and Selections

INSTALLATION

Table 1: Configuration Menu Options

Table 1: Configuration Menu Options				*Factory Default Setting
No.	Option Menu Item	Option Display	Selections Menu	Description / Notes
1	Active Fault Menu	<i>Err</i>	“Exx”	Cycles through up to 4 active errors. XX=2 digit Fault Code ex. E01
2	Firmware Version	<i>Er</i>	“rXX”	Displays Firmware Version Number
3	Display Selected Harness Configuration	<i>dSH</i>	“Hxx”	Displays Harness / Connector (Auto) Configuration ex. H23
4	Reset to Factory	<i>rSt</i>	no*, yES	Resets configurations to factory defaults
5	Clear Harness Configuration	<i>CHC</i>	no*, yES	Clears Harness / Connector auto configuration data from memory
6	Blower Motor Type Selection	<i>bLr</i>	PS2*, PS3, EC2, EC3, EC4, EC5, EC9	Select according to OEM motor type either: PSC-2 & 3 speed, or ECMx 2, 3, 4, 5 or 9 speed
7	Pre-purge	<i>PrE</i>	15, 30*	Duration (Seconds)
8	Inter-purge	<i>Int</i>	15, 30, 45, 60*	Duration (Seconds)
9	Post purge	<i>PSt</i>	5, 10, 15, 25*, 30, 90	Duration (Seconds)
10	Constant Fan Speed ECMx	<i>Fsd</i>	Fxx (xx: Blower Speed Number) Default – F01	Fan Speed Setting for ECMx Blower Connectors (6-Pins)
11	1st Stage Cool Speed ECMx	<i>CS1</i>	Fxx (xx: Blower Speed Number) Default – F04	Low Cool Setting for ECMx Blower Connectors (6-Pins)
12	2nd Stage Cool Speed ECMx	<i>CS2</i>	Fxx (xx: Blower Speed Number) Default – F05	High Cool Speed Setting for ECMx Blower Connectors (6-Pins)
13	Heat Speed ECMx	<i>Hsd</i>	Fxx (xx: Blower Speed Number) Default – F01	Heat Speed Setting for ECMx Blower Connectors (6-Pins)
14	Fan On Delay	<i>Fnd</i>	0*, 2, 5	Duration (Seconds)
15	Fan Off Delay	<i>FFd</i>	0*, 2, 60, 90, 120, 180	Duration (Seconds)
16	Cool On Delay	<i>Cnd</i>	0, 2, 3, 5, 6*	Duration (Seconds)
17	Cool Off Delay	<i>CFd</i>	0, 2, 3, 5, 45*, 60, 80, 90	Duration (Seconds)
18	Heat On Delay	<i>Hnd</i>	15, 20, 22, 25, 30*, 40, 45, 60, 66	Duration (Seconds)
19	Heat Off Delay	<i>HFd</i>	60, 90, 100*, 120, 135, 140, 150, 160, 180, 225	Duration (Seconds)
20	Automatic Heat Staging (Hybrid Only)	<i>AHS</i>	OFF, 05, AUt*	Staging Time for Goodman Hybrid System – See Application Notes pg. 5
21	Rollout Input Bypass	<i>rOb</i>	no*, yES	Bypass Rollout Input – See Applications Notes pg. 6
22	Self-Test Mode	<i>StE</i>	no*, yES	Initiates Self-Test Mode

Note: Table 1 shows every configuration option available on 50M56X-843. However, not all OEMs use the same configuration options. Once the automatic configuration process is complete, some settings not relevant to the detected OEM application may no longer appear in the control's menu or WR Connect app.

Tip: Note the settings on the OEM control being replaced in the space in the margins of this manual or by circling the corresponding setting value in the selections menu column in Table 1.

INSTALLATION

NOTE: All wiring should be installed according to local and national electrical codes and ordinances

1. Disconnect electrical power and shut off gas supply to unit, then remove unit access panels.
2. Mark and disconnect all wires from the existing control, then remove existing control. **Tip:** Take a photo of the old control wiring for reference.
3. Mount 50M56X-843 in the unit using one of the mounting options noted in the **Mounting** section. Be certain not to damage any components such as wire harnesses or blower wheels when drilling or installing screws.
4. Identify the connector type on the board being replaced and/or the OEM wiring harness and attach it to the appropriate mating connector on the 50M56X-843 control. **Note:** Some mating connectors on the control have subtle differences such as pins vs sockets in the connector, see the **Wiring Diagrams** section for more info on proper OEM connector identification.
5. Connect all the remaining individual wires to the new 50M56X-843 control board referencing the **Wiring Diagrams** section as needed.
6. Ensure all wires and connectors are secured to the control board and unused blower speed wires are attached to the PARK terminals. **Note:** PARK terminals are 3/16" spades but can be used to store unused PSC (1/4") or ECMx (3/16") speed taps since PARK terminals do not provide an electrical connection to the attached motor leads.
7. Use the WR Connect App or 7-Segment display to match the settings of the OEM control as described in the **Configuration** and **Application Notes** sections.
8. Install the included HotRod™ ignitor. **Note:** This is recommended for all units but is required for all 80V controls listed in the **Application Notes** section.
9. Allow the control to complete its **Automatic Configuration** sequence (takes about 30 seconds).
10. Reinstall unit access panels and reconnect electric power. Restore gas supply to the unit. Verify unit operation in heating, cooling, and fan only modes.

MOUNTING

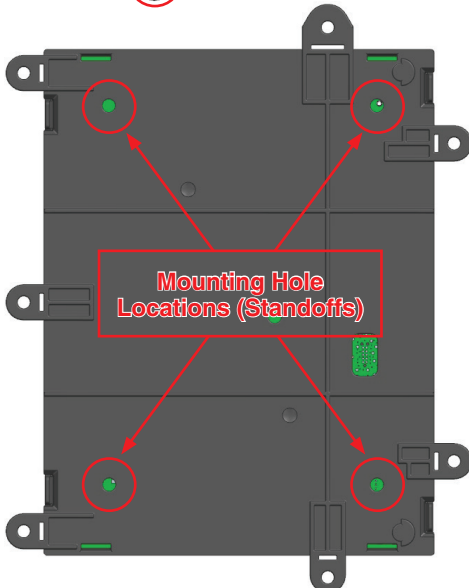
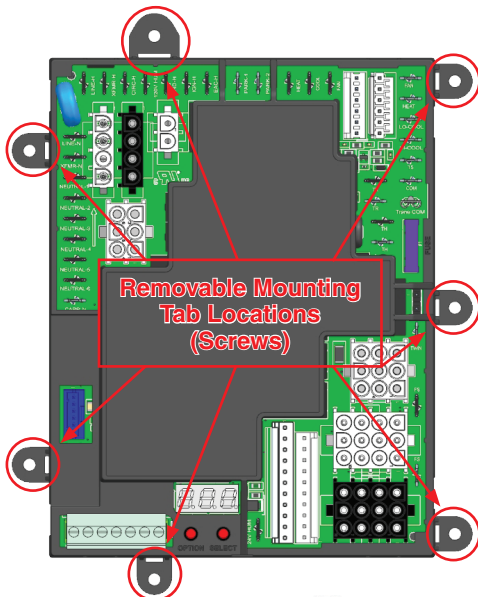

50M56X-843 can be mounted in any orientation and has multiple mounting points designed to align with many common OEM designs. Take note of how the original control was mounted, and if possible utilize the same method for the replacement. However, an exact alignment with an OEM mounting pattern is not required as the control can be mounted to any suitable sheet metal surface in the furnace.

Mounting Tabs & Screws: Any of the 7 tabs around the perimeter of the control can be used to secure the control in conjunction with the included 1/2" self drilling sheet metal screws. Unless there is a specific OEM mounting method that is being replicated (which involves additional support points from the OEM bracket) a minimum of 2 sheet metal screws is recommended to adequately secure the control, but up to 4 can be used. The mounting tabs have been designed to be easily cut off with a pair of snips or sidecutters to gain additional mounting space if needed.



Mounting Holes & Standoffs: The included standoffs are designed to be used in conjunction with common OEM standoff mounting patterns. For standoff mounting, plug standoffs directly into the 4 corner holes on the back side of the plastic tray. Once standoffs are secured to the tray lock the standoffs into matching locations in the sheet metal bracket with firm even pressure on the control cover.



APPLICATION & OPERATION NOTES

Ignitor Replacement

The following cross reference control numbers are for 80V ignition systems that must be upgraded to 120V by replacing the OEM ignitor with the included HotRod™ ignitor. However, it is recommended to replace original 120V ignitors as well.

10207720	23W5101	50A65-475	56L8401	CNT07737	D342359P01
100925-01, -02, -03	30W25	50A65-476	69M08	CNT07738	D342359P02
102077-17	30W2501	50A65-5165	69M0801	CNT3076	D342359P03
10207720, S	32M88	50A65-843	69M15	CNT3742	D342359P04
10M93	32M8801	50A66-843	69M1501	CNT3798	L43-226
10M9301	350836	50A67-476-01	CNT03076	CNT5164	L46-846
12L69	3XA76	50A67-476-02	CNT03742	CNT5165	PCBBF118, S
12L6901	50A65-120, -121, -122, -123, -743	50A67-507-01	CNT03798	D341213P01	X13650818030
17W92	50A65-143	50A67-507-02	CNT04711	D341396P01	
17W9201	50A65-288	56L83	CNT05164	D341396P03	
21D83M-843	50A65-289	56L8301	CNT05165	D341396P04	
23W51	50A65-474	56L84	CNT06664	D341396P05	

Goodman Hybrid 2-Stage Compatibility (Special Case)

The following cross references are for controls related to a unique system known as the “Goodman Hybrid.” This “Hybrid” system is comprised of a furnace with a 2-stage gas valve paired with a single speed (always high) inducer motor and a single stage blower motor. 50M56X-843 is able to operate these unique applications in addition to standard single stage furnaces. These furnaces rely on logic in the control (rather than a 2-stage thermostat) to shift between 1 and 2 stage heating. **Configuration** menu item number 20 allows the control to utilize either a fixed timing (5 minutes) or an adaptive algorithm for heat staging. Alternatively, the staging can be turned off completely and the control will operate as standard 1-stage IFC.

PCB00109	PCBBF109	PCBBF109S	PCBBF122
PCBBF122S	PCBBF132	PCBBF132S	

Air Conditioner & Heat Pump

- Systems retrofitted with 50M56X-843 can be paired with either a 1 or 2 stage air conditioner or heat pump.
- When paired with a 1-stage unit, connect the Y output from the thermostat to Y/Y2 input on the control. For 2-stage units, connect the Y1 output from the thermostat to the Y1 input on the control and the Y2 output from the thermostat to the Y/Y2 input on the control.

50M56X-843 will provide auxiliary heating during a heat pump defrost cycle if it receives heat and cool calls simultaneously (W + any Y)

Dehumidification

Note: This feature requires connection to a thermostat with a dehumidification function (DHUM terminal).

- DHUM input is reverse logic in that presence of a 24V signal = no dehumidify demand, and absence of a 24V signal = dehumidify demand
- Dehumidify demand with a Y1 input runs the blower at the speed selected for constant fan (heat speed is default) for those applications that do not have a dedicated low cool speed
- Dehumidify demand with a Y / Y2 input runs the blower at the cool speed for 10 minutes, then reduces the blower speed from cool to low cool (constant fan) for 10 minutes, then returns to the cool speed for 10 minutes
- Alternating 10-minute cycles continue for as long as there is a call for High Stage cooling (Y/Y2)
- When the call for cool is satisfied and there is a dehumidify demand, the blower off delay is reduced to 5 seconds

Automatic Configuration Process

50M56X-843 automatically configures its functional operation (including connector pinouts and certain menu options) to match that of the OEM furnace and control being replaced across a variety of applications. This process allows for plug and play wiring of multiple OEM harnesses with different pinouts into the same physical connector on the 50M56X-843 control, and thus the elimination of adapter harnesses from the kit. This process takes approximately 30 seconds at first power up and must be allowed to complete to ensure proper operation. Automatic configuration is discussed in further detail below for informational and troubleshooting purposes.

Note: Most settings listed in the **Configuration Menu** table will remain user configurable and in their default state and may require further adjustment to match that of the OEM control.

During the automatic configuration process the control is able to configure for specific OEM applications and harness pinouts by detecting differences in OEM wiring and which

APPLICATION & OPERATION NOTES

loads are present on specific connector terminals. **It is critical that system wiring match one of the scenarios outlined in the Wiring Diagrams section and that all system components (such as inducer motors and pressure switches) are operating properly prior to automatic configuration taking place.**

Automatic configuration occurs during the first power up and is verified at the next power up. After the same application is detected 2 consecutive times, the corresponding configuration is written to memory and automatic configuration will no longer occur at power up. However once stored, the automatic configuration can always be cleared using menu option 5 (CHC). If an automatic configuration error code (E41) is reported, verify all wiring connections are correct, all components in the system are present and functioning properly before power cycling the control and attempting another automatic configuration process.

Note: A single valid automatic configuration is sufficient to proceed with control installation and verification testing.

Blower Type Selection and Speed Settings

50M56X-843 is able to replace furnaces with PSC or ECMx (constant torque) blower motors. The motor type present in the furnace must be configured by the installer based on the options in the Configurations Menu option number 6 (BLr). PSC options include 2 speed (heat & cool) or 3 speed (heat, cool, and fan). ECMx options include 2 (heat & hi-cool), 3 (heat, hi-cool, & fan), 4 (heat, lo-cool, hi-cool, & fan), 5, and 9 speed options. For 5 (F01 – F05) and 9 (F01-F09) speed blowers use the **Configuration Menu** to select the appropriate speed for cool, heat, and fan. For 2 speed motors constant fan (G) calls will default to the heat speed.

Note: If additional fan speed connections are available via the motor wiring but not in use, the system can be upgraded to operate with additional blower speeds in certain scenarios, for example constant fan, dehumidification, and/or high and low cooling. Reference OEM literature for more information on fan speed connections and approximate CFM.

Roll Out Configuration

Certain Trane, American Standard, and York (including York P3UR / PCLU) furnaces do not have an individually monitored rollout switch in their main harness wiring configuration and instead place the rollout switch in series with other limit switches for example the high limit (HL) switch. As these models share the same connector #8 in the **Wiring Diagrams** with other OEMs that utilize a separately monitored rollout switch between pins 5 and 11. Instead of using a physical shunt jumper or wire accessory to bypass the rollout input for these applications, changing **Configuration Menu** setting number 21 (r0b) to 5E5 will digitally bypass the rollout inputs.

Note: Failure to bypass the rollout input for certain Trane, American Standard, and York furnaces that do not require one will disable furnace operation and result in a rollout switch open error (E07).

OEM Wiring Terminal Spacing Connector Retrofit (Special Case)

Some OEM furnaces, for example Trane and American Standard, have a plastic connector housing that groups together line and neutral spade terminals. This is done so they can plug onto OEM controls all at once saving time

on the manufacturer's production line albeit at a cost of expanded spacing and therefore limited room for additional accessory terminals such as electronic air cleaners and 120V humidifiers.

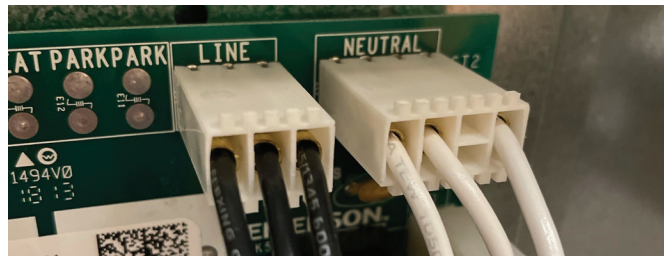

If encountered during replacement, simply snip off the wire near the plastic connector housing, strip the insulation, and crimp on one of the provided 1/4" female spade terminals. Then connect the black wires to Line terminals (Line-H, XFMR-H, & CIRC-H) and connect white wires to neutral terminals.

Note: The 3 line connections (Line-H, XFMR-H, & CIRC-H) are electrically continuous as are all neutral terminal connections. As such, the order of connection is arbitrary in a retrofit scenario as long as all 120V line connections (black wires) are connected to a line terminal and all 120V neutral connections (white wires) are connected to a neutral terminal.

FLAME SENSOR KIT Required on RHEEM/ RUUD Models (1994 and earlier)

If the control being replaced has 2 green lights (no amber light), and a date code of 3294 or earlier, a Flame Sensor Kit, RHEEM part number 62-24044-71 is required (not available through White-Rodgers).

Replacing Previously Installed Universal Controls

When replacing a failed Resideo/Honeywell H9200U1000, ICM ICM2812-KIT & ICM-2812, or White-Rodgers 50M56U-843 & 50X57-843 (unlikely scenario), identify and remove any wiring adapter harness between OEM furnace wiring and the failed universal control prior to replacement with 50M56X-843.

Status Display During Active Calls

During an active call for heat, cool, or constant fan, the display will alternate between up to 3 status indicators. As outlined in Table 2, the first indicator will display the active call from the thermostat. If applicable the active motor speed selection will also be displayed alongside flame current (in heating mode only). If an active error code is present, it will be displayed in an alternating pattern with the others discussed above.

WIRING DIAGRAM

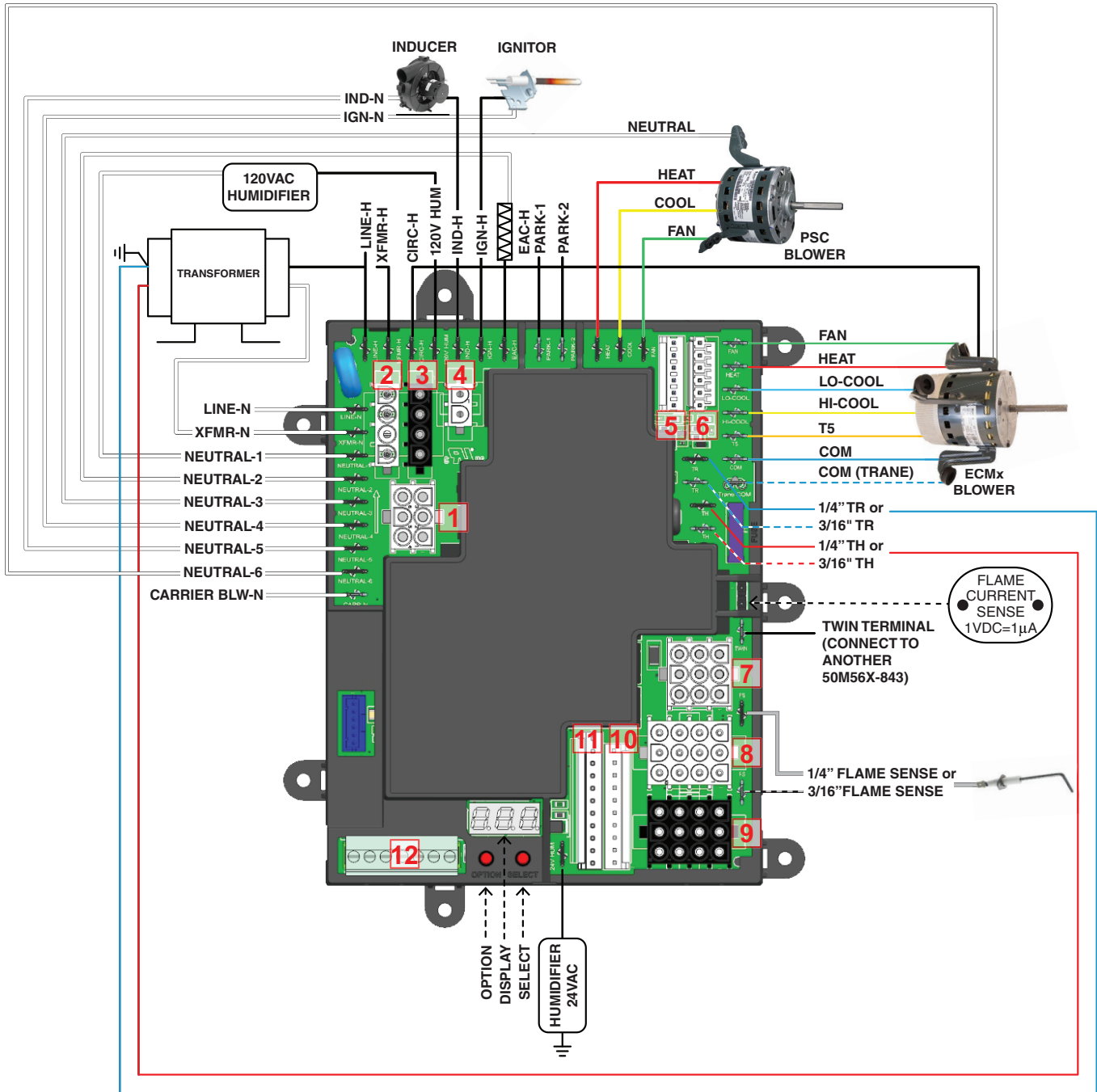

Properly Matching OEM Wiring Harness Connectors with 50M56X-843 Connectors

- Identify connector type in OEM harness or on the OEM control and plug OEM wiring directly onto matching connector on 50M56X-843
- No adapter harnesses are necessary, remove previously installed adapter harnesses if present
- **Take extra care with connectors that are visually similar such as 2 & 3, 5 & 6, 8 & 9, 10 & 11**
- Black connectors on 50M56X-843 contain sockets (which mate with harnesses containing pins)

- White connectors on 50M56X-843 contain pins (which mate with harnesses containing sockets)
- White & black connectors on 50M56X-843 may mate with different colored harness connectors
- **For 2 & 3:** 2 is white indicating pins, 3 is black indicating sockets
- **For 5 & 6:** 5 does not have a latch, 6 does have a latch (see details below)
- **For 8 & 9:** 8 is white indicating pins, 9 is black indicating sockets
- **For 10 & 11:** 10 has 10 pins, 11 has 11 pins. Match OEM connector to proper pin number

WIRING DIAGRAM

1 6-Socket: Nordyne/Nortek Configuration

#	DESCRIPTION
1	INDUCER HOT
2	(OPEN)
3	IGNITOR HOT
4	INDUCER NEUTRAL
5	(OPEN)
6	IGNITOR NEUTRAL

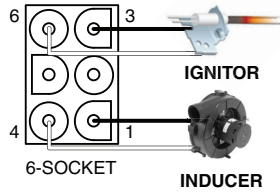

6-Socket: Rheem/Ruud Configuration

#	DESCRIPTION
1	IGNITOR HOT
2	(OPEN)
3	IGNITOR NEUTRAL
4	INDUCER HOT
5	(OPEN)
6	INDUCER NEUTRAL

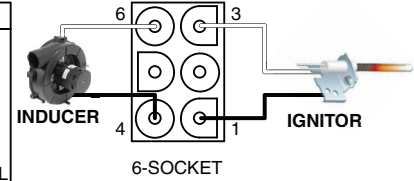

2 4-Pin: Goodman/Amana/Trane/American Standard/Lennox/ Allied Air/York/Coleman/Luxaire Configuration

#	DESCRIPTION
1	INDUCER HOT
2	IGNITOR HOT
3	INDUCER NEUTRAL
4	IGNITOR NEUTRAL

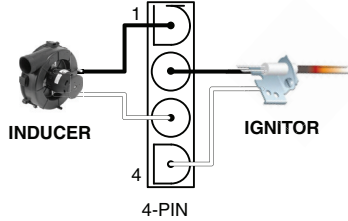

#	DESCRIPTION
1	IGNITOR HOT
2	INDUCER HOT
3	INDUCER NEUTRAL
4	IGNITOR NEUTRAL

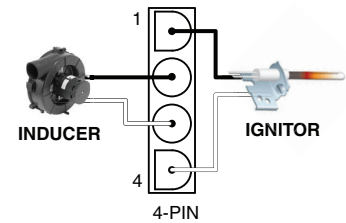

3 4-Socket: Lennox/Allied Air

#	DESCRIPTION
1	INDUCER HOT
2	IGNITOR HOT
3	INDUCER NEUTRAL
4	IGNITOR NEUTRAL

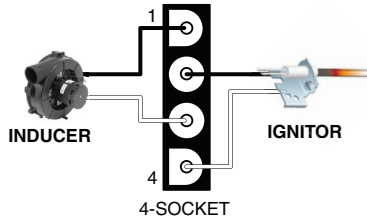

4 2-Pin: Goodman/Amana Configuration

#	DESCRIPTION
1	INDUCER HOT
2	IGNITOR HOT

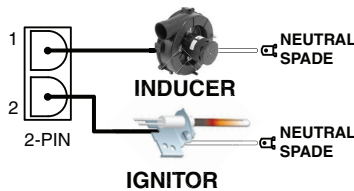

2-Pin: Carrier/Bryant/Payne/ICP Configuration

#	DESCRIPTION
1	IGNITOR HOT
2	INDUCER HOT

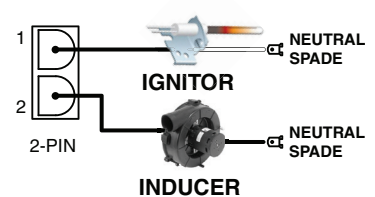

5 6-Pin Inline: Trane/American Standard

#	DESCRIPTION
1	TAP 1
2	TAP 2
3	TAP 3
4	TAP 4
5	TAP 5
6	GND

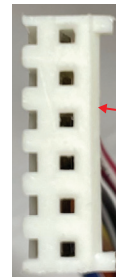
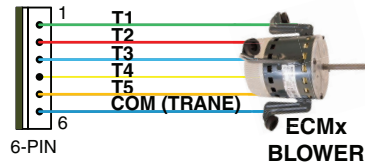

No Latch:
Place on
Left Hand
Side 6 Pin
Connector



6 6-Pin Inline: Goodman/Amana

#	DESCRIPTION
1	GND
2	TAP 5
3	TAP 4
4	TAP 3
5	TAP 2
6	TAP 1

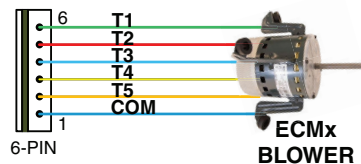

Latch:
Place on
Right Hand
Side 6 Pin
Connector

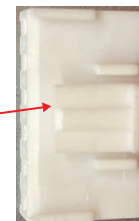

WIRING DIAGRAM

7 9-Socket: Goodman/Amana Configuration

#	DESCRIPTION
1	(OPEN)
2	PRESSURE SWITCH OUT
3	TRANSFORMER HIGH
4	(OPEN)
5	HIGH LIMIT IN
6	TRANSFORMER RETURN
7	MAIN VALVE OUT
8	PRESSURE SWITCH IN
9	HIGH LIMIT OUT

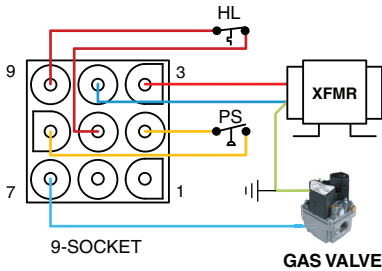

9-Socket: Goodman/Amana Alt. Configuration

#	DESCRIPTION
1	(JUMPER TO PIN 4)
2	PRESSURE SWITCH OUT
3	TRANSFORMER HIGH
4	(JUMPER TO PIN 1)
5	HIGH LIMIT IN
6	TRANSFORMER RETURN
7	MAIN VALVE OUT
8	PRESSURE SWITCH IN
9	HIGH LIMIT OUT

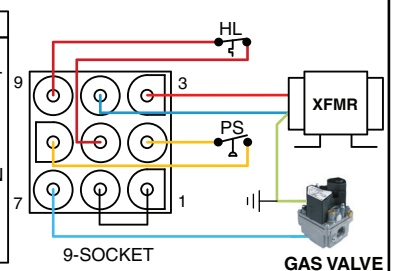

9-Socket: Nordyne/Nortek/Rheem/Ruud Configuration

#	DESCRIPTION
1	(OPEN)
2	MAIN VALVE COMMON
3	HIGH LIMIT IN
4	MAIN VALVE OUT
5	PRESSURE SWITCH IN
6	PRESSURE SWITCH OUT
7	FLAME SENSE IN
8	HIGH LIMIT OUT
9	GND

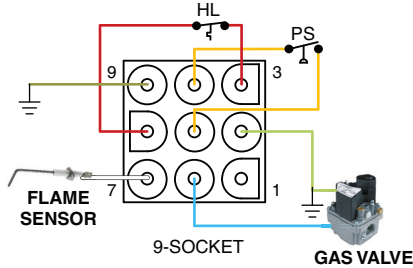

8 12-Pin: Goodman/Amana/Trane/American Standard/Lennox/Allied Air/York/Coleman/Luxaire Configuration

#	DESCRIPTION
1	HIGH LIMIT OUT
2	FLAME SENSE IN
3	TRANSFORMER HIGH
4	PRESSURE SWITCH OUT
5	ROLLOUT SWITCH OUT
6	TRANSFORMER RETURN
7	HIGH LIMIT IN
8	CHASSIS GROUND
9	MAIN VALVE COMMON
10	PRESSURE SWITCH IN
11	ROLLOUT SWITCH IN
12	MAIN VALVE OUT

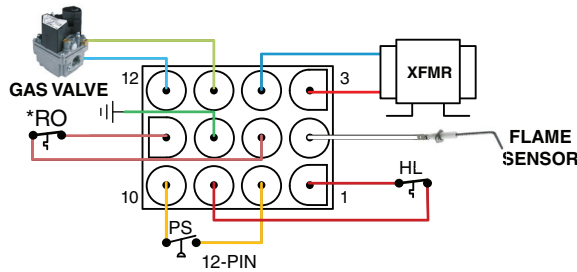

Note *: - Rollout switch not available on some Trane, American Standard, and York models
 - See **Application Notes** for rollout input bypass instructions on these models
 - Failure to configure rollout input correctly will result in rollout error code

12-Pin: Goodman Hybrid Configuration

#	DESCRIPTION
1	HIGH LIMIT OUT
2	MAIN VALVE LOW OUT
3	TRANSFORMER HIGH
4	PRESSURE SWITCH OUT
5	ROLLOUT SWITCH OUT
6	TRANSFORMER RETURN
7	HIGH LIMIT IN
8	CHASSIS GROUND
9	MAIN VALVE COMMON
10	PRESSURE SWITCH IN
11	ROLLOUT SWITCH IN
12	MAIN VALVE HIGH OUT

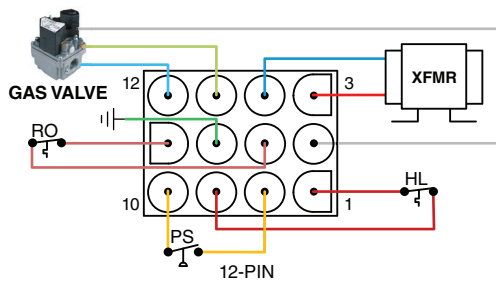

9 12-Socket: Lennox/Allied Air

#	DESCRIPTION
1	HIGH LIMIT OUT
2	FLAME SENSE IN
3	TRANSFORMER HIGH
4	PRESSURE SWITCH OUT
5	ROLLOUT SWITCH OUT
6	TRANSFORMER RETURN
7	HIGH LIMIT IN
8	CHASSIS GROUND
9	MAIN VALVE COMMON
10	PRESSURE SWITCH IN
11	ROLLOUT SWITCH IN
12	MAIN VALVE OUT

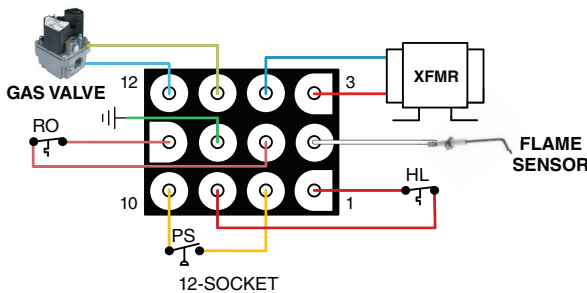

WIRING DIAGRAM

10 10-Pin Inline: Trane/American Standard

#	DESCRIPTION
1	INDUCER LIMIT IN
2	TRANSFORMER RETURN
3	PRESSURE SWITCH IN
4	HIGH LIMIT OUT
5	MAIN VALVE COMMON
6	TRANSFORMER HIGH
7	CHASSIS GROUND
8	MAIN VALVE OUT
9	HIGH LIMIT IN
10	FLAME SENSE IN

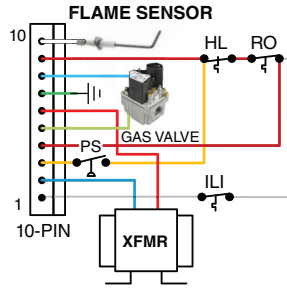

10-Pin Inline: Trane/American Standard Alt. Configuration

#	DESCRIPTION
1	OPEN
2	TRANSFORMER RETURN
3	PRESSURE SWITCH IN
4	HIGH LIMIT OUT
5	MAIN VALVE COMMON
6	TRANSFORMER HIGH
7	CHASSIS GROUND
8	MAIN VALVE OUT
9	HIGH LIMIT IN
10	FLAME SENSE IN

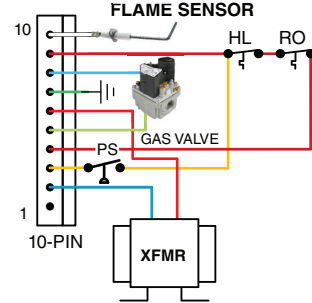

11 11-Pin Inline: Carrier/Bryant/Payne/ICP

#	DESCRIPTION
1	FLAME SENSOR IN
2	PRESSURE OUT
3	(SEE 11 PIN DETAIL)
4	PRESSURE IN
5	GAS VALVE GND
6	LIMIT OUT
7	(SEE 11 PIN DETAIL)
8	LIMIT IN
9	(SEE 11 PIN DETAIL)
10	GAS VALVE OUT
11	(SEE 11 PIN DETAIL)

11-Pin Detail: PIN 3 - Housing Pressure Switch Input

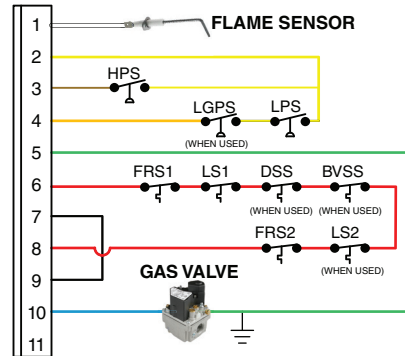

11-Pin Detail: PIN 3 - Not Connected

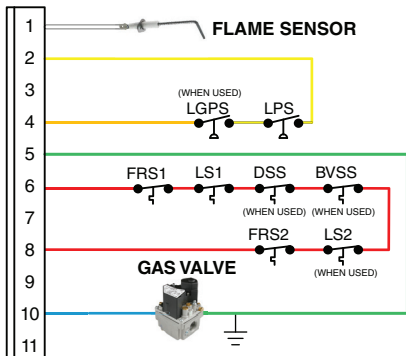

11-Pin Detail: PIN 3 - Inducer Ground

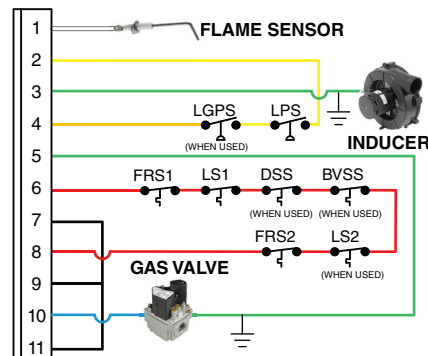

12 Thermostat Connections

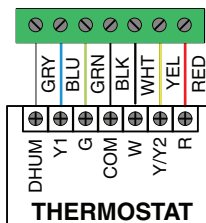

Note: Detailed wiring diagrams for connectors 1-12 are only representative of the general interconnection between control inputs and outputs (e.g. PSI & PSO) and system components (e.g. pressure switch). OEMs often place multiple limit devices and pressure switches in series. Reference OEM wiring diagrams for additional info. Wire colors may not match all systems.

TROUBLESHOOTING

Table 2: 7-Segment Display Codes

Condition	LED 1	LED 2	LED 3	Comment/Troubleshoot Step
Line Frequency Error / Internal Fault	E	0	0	Verify 60 Hz line frequency, Replace control
Pressure Switch Open	E	0	1	Check pressure switch, inducer, and flue
Flame Detected When no Flame Should be Present	E	0	4	Check gas valve for proper operation, check gas valve and safety limit wiring
Open Fuse	E	0	6	Locate & repair 24V fault, replace fuse
Rollout Switch Open	E	0	7	Check for rollout condition or failed switch
Pressure Switch Stuck Closed	E	0	9	Replace failed pressure switch
Gas Valve On Error	E	1	1	Check gas valve operation and wiring
Gas Valve Off Error	E	1	2	Check gas valve operation and wiring
Ignitor Relay Fault	E	1	3	Internal ignitor relay failure, replace control
Ignitor Open Failure	E	1	4	Replace failed ignitor
Grounding Error	E	1	5	Check control & furnace ground connections
Reversed Line Polarity	E	1	6	Hot and neutral wires are reversed
Twinning Error	E	1	7	Validate twin configuration for both units
High Limit Switch Open	E	1	8	Check for open/failed HL & any aux switches
Lockout - Retries Exceeded	E	2	1	Lockout after unsuccessful trial for ignition
Lockout - Gas Valve Off	E	2	2	Gas valve relay internal error, replace control
Lockout - Recycles Exceeded	E	2	3	Lockout after failed relight due to flame loss
Lockout - Pressure Switch Open	E	2	4	Lockout due to open pressure switch
Lockout - HPS Open	E	2	5	Lockout for Housing P.S. on condensing units
HPS Stuck Closed	E	3	1	Housing P.S. stuck closed - condensing units
HPS Open	E	3	2	Housing P.S. not closing - condensing units
Auto Configuration Error	E	4	1	See Automatic Configuration Process Notes
NFC Connectivity Error	E	⌈	1	NFC comm error, power cycle control & retry
Continuous Fan (G)	F	A	n	Active call for constant fan
Standby	0	n		Ready to access menus or respond to calls
Control Power Up	8	8	8	Displayed at initial power up
Blower on After Power up	b	0	n	Cool down after power loss with active call
Gas Heat (W) Present before pre-purge or during error conditions	h	t	P	Gas heat call active before inducer pre purge or with error conditions that prevent ignition
Gas Heat (W) with Pre-Purge Active	h	P	r	Gas heat call active during pre-purge period
Gas Heat (W) with Inter-Purge Active	h	1	P	Gas heat call active during inter-purge period
Gas Heat (W) with Post-Purge Active	h	P	o	Gas heat call active during post-purge period
Gas Heat (W) Ignitor Warm-up Period Active	1	9	n	Gas heat call active during ignitor warm-up period
Gas Heat (W) Trial for Ignition Period Active	t	F	1	Gas heat call active during trial for ignition period
Gas Heat (W) after flame is active	h	t		Gas heat call with flame present
Single Stage Gas Heat Active (W)	h	t	1	1 st stage gas heating – Goodman Hybrid only
Goodman Hybrid Only - 2nd Stage Gas Heat (Autostage)	h	t	2	2 nd stage gas heating – Goodman Hybrid only, 2 nd stage timing based on AHS menu setting
Single / High Stage Cooling (Y/Y2)	⌈	⌋		Call for high cooling with 1 or 2 stage AC/HP
Low Stage Cooling (Y1)	⌈	⌋	1	Call for low cooling – For 2 stage AC/HP only
Low Flame Current Sense	F	⌋	o	Check Flame Quality, Clean/Replace Flame Sensor
Auto Configuration in Progress	d	⌈	F	Allow 30 seconds for the control to configure

TROUBLESHOOTING

Operation	Module Status	Action	Duration of Action	LED Display	Extra Notes
Fault Code Recall	Standby	Hold OPTION and SELECT together	2-5 sec.	<i>F L t</i> after 2 sec.	<ul style="list-style-type: none"> A maximum of 5 error codes are stored in the sequence they occur Press OPTION button < 1 second to advance to next fault code When OPTION button is pressed after last error code, LEDs return to current status of unit <i>E n o</i> will be displayed if there are no error codes stored
Fault Code Reset	Standby	Hold OPTION and SELECT together	5-10 sec.	Alternates between <i>[- L r</i> and <i>F L t</i> after 5 sec.	<ul style="list-style-type: none"> Once both OPTION and SELECT are released after holding them together for 5-10 seconds, the LEDs will flash <i>[- L r</i> 3 times to indicate the error codes have been erased, module will then return to current status Error codes are stored in the module's memory for up to 14 days

Note: Thermostat calls are ignored when module is in Error Code Recall or Reset modes

Control Reset

Control reset is automatic after 1 hour in lockout. Removing 24 VAC power to the control for greater than 10 seconds will manually reset (power cycle) the control.

Flame Current Display & Test Pins

50M56X-843 has an advanced flame current sense circuit that allows the control to digitally measure and report flame current on the 7-segment display with 0.1 µA resolution. As discussed in **Application & Operation Notes**, flame current is automatically displayed in an alternating pattern with other status indications during a heat call.

Flame current can also be measured with a voltmeter using the test pins in the location noted in the wiring diagram. When using this method set the meter to volts DC and place the probes on each test pin. If a negative reading is observed, simply reverse the polarity of the meter leads. The reading in volts is directly equivalent to a direct microamp reading of the flame current (1VDC = 1 µA).

Self-Test Mode

Self-test mode allows the control to test most furnace components without requiring a call for heat. Enter self-test mode through the configuration menu option number 22 (*5tE*)

NOTE: Control will terminate Self-Test mode and display the corresponding error code if any system fault occurs. Control will ignore any active thermostat calls during Self-Test.

Sequence is as follows:

- Upon self-test mode entry, the display will flash 3 sets of dashes (- - -) 3 times
- If any error codes have been stored, they will be displayed, if none are stored *E n o* will be displayed
t5t will be displayed indicating test mode is active and will be alternated with an indicator code for the current step
- The inducer motor will turn on and remain on throughout test mode and *l n d* will be alternated with *t5t*
- The ignitor will turn on for 15 seconds and *i g n* will be displayed alternating with *t5t*
- The blower motor runs at the Fan, Heat, and Cool speeds (based on configuration settings) respectively for 10 seconds each. *F A n*, *h t*, and *[- L* will be displayed when the corresponding blower speed is on alternating with *t5t*
- Blower and Inducer motors turn off. Self-Test is complete, display will show *[- n* indicating Standby mode

TECHNICAL SUPPORT: 1-888-725-9797

WHITE-RODGERS